

SCHIEDEL ICS
Systembauteile

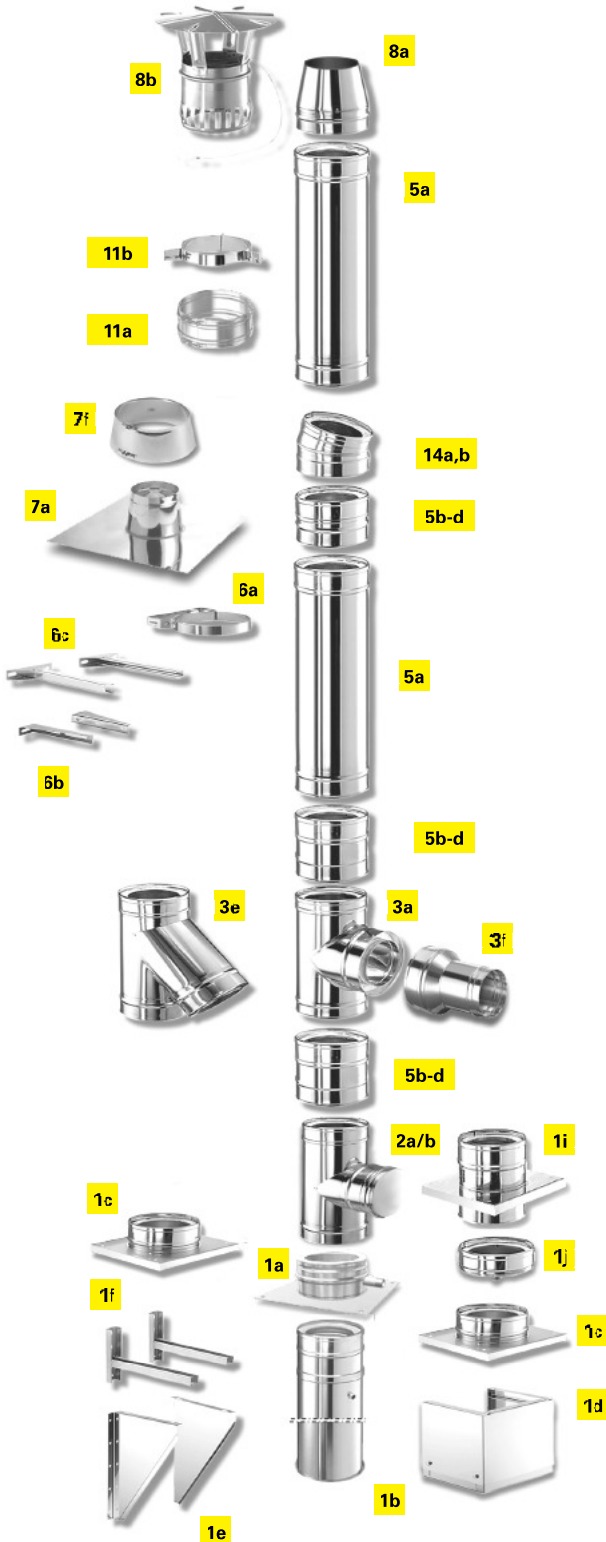

**Perfekt aufeinander abgestimmte
Systembauteile**

- 1a ICS Grundplatte
- 1b ICS Fußteil für Bodenmontage
- 1c ICS Grundplatte Kondensatablauf nach unten
- 1d ICS Teleskopstütze
- 1e ICS Verlängerte Wandkonsole (Paar)
- 1f ICS Montageschienen für Wandkonsole (Paar)
- 1i ICS Zwischenstütze
- 1j ICS Kondensatschale
- 2a ICS Putzanschluss
- 3a ICS T-Stück 90°
- 3e ICS T-Stück 45°
- 3f ICS Anschlussübergang
- 5a ICS Rohrelement 955
- 5b ICS Rohrelement 455
- 5c ICS Rohrelement 205
- 5d ICS Rohrelement 155
- 6a ICS Wandhalter
- 6b ICS Verlängerung für Wandhalter klein
- 6c ICS Verlängerung für Wandhalter
- 7a ICS Dachdurchführung 0°
- 7f ICS Regenkragen
- 8a ICS Mündungsabschluss
- 8b ICS Regenhaube (bis Ø 300)
- 8c ICS Regenhaube (bis Ø 350) o. Abb.
- 11a ICS Statisches Klemmband
- 11b ICS Seilabspannring
- 14a ICS Bogen 15°
- 14b ICS Bogen 30°

HINWEIS

Variante 1: wie Standardausführung, jedoch Wärmedämmung = 50 mm, Aufpreis + 10%
Variante 2: Innenrohrwandstärke = 1,0 mm, Wärmedämmung = 50 mm, Aufpreis = + 25%

SCHIEDEL ICS

Lieferprogramm (Stand 2010)

Lichter Ø	80	100	130	150	180
-----------	----	-----	-----	-----	-----

1a



Grundplatte Bodenmontage

mit Kondensatablauf seitlich

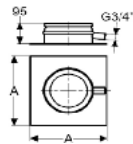

Art.-Nr.	—	266000110	266000113	266000115	266000118
Gewicht kg/Stk.		1,55	3,19	3,34	4,35
Nutzlänge (NL)		95	95	95	95
A		300	320	350	350

1b



Fußteil für Bodenmontage

mit Kondensatablauf; kürzbar nach Bedarf

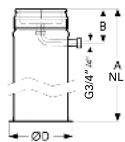

Art.-Nr.	266000208	266000210	266000213	266000215	266000218
Gewicht kg/Stk.	2,41	2,71	3,05	3,44	4,07
Nutzlänge (NL)	1045	1045	1045	1045	1045
A	160	160	160	160	160
ØD	176	196	226	246	276

1c



Grundplatte

Kondensatablauf nach unten
Wandmontage: auf Pos. 1f, 1e
Bodenmontage: auf Pos. 1d

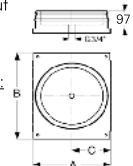

Art.-Nr.	266000408	266000410	266000410	266000415	266000418
Gewicht kg/Stk.	2,05	2,57	3,19	3,64	4,35
Nutzlänge (NL)	97	97	97	97	97
A	185	205	235	255	275
B	250	270	300	320	350
C	80	90	105	115	130

1d

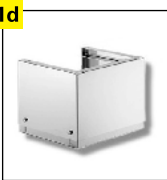

Teleskopstütze

passend zu Pos. 1c

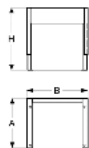

Art.-Nr.	266000808	266000810	266000813	266000815	266000818
Gewicht kg/Stk.	5,71	6,20	6,93	7,42	8,15
A	182	202	232	252	272
B	250	270	300	320	350
H	33-500	300-500	300-500	300-500	300-500

1e



Konsolblech (Paar)

für Wandmontage passend zu Pos. 1c
Wandabstand 50 mm

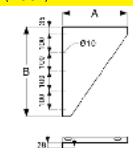

Art.-Nr.	266000608	266000610	266000613	266000615	266000618
Gewicht kg/Stk.	2,20	2,39	2,85	3,14	3,32
A	220	240	270	290	310
B	470	470	470	470	470

1f



Montageschienen für Wandkonsole (Paar)

für Wandmont.; passend zu Pos. 1c
Ausführung bei Typ 325 u. 475:

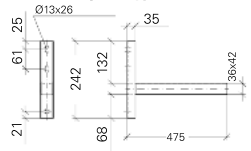

Ausführung bei Typ 570-1504

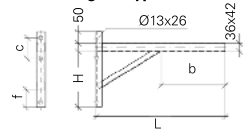

Typ = L	H	b	c	f
570	238	139	91	100
720	238	289	91	100
820	288	390	91	70
1004	288	390	91	70
1120	338	364	91	70
1304	358	428	120	70
1504	678	398	120	70

	80	100	130	150	180
max. WA* bei "Typ 325"	157	137	107	87	—
Art.-Nr.	267120325	267120325	267120325	267120325	—
max. WA* bei "Typ 475"	307	287	257	237	217
Art.-Nr.	267120475	267120475	267120475	267120475	267120475
max. WA* bei "Typ 570"	402	382	352	332	312
Art.-Nr.	267120570	267120570	267120570	267120570	267120570
max. WA* bei "Typ 720"	552	532	502	482	462
Art.-Nr.	267120720	267120720	267120720	267120720	267120720
max. WA* bei "Typ 820"	652	632	602	582	562
Art.-Nr.	267120820	267120820	267120820	267120820	267120820
max. WA* bei "Typ 1004"	836	816	786	766	746
Art.-Nr.	267121004	267121004	267121004	267121004	267121004
max. WA* bei "Typ 1120"	952	932	902	882	862
Art.-Nr.	267121120	267121120	267121120	267121120	267121120
max. WA* bei "Typ 1304"	1136	1116	1086	1066	1046
Art.-Nr.	267121304	267121304	267121304	267121304	267121304
max. WA* bei "Typ 1504"	1336	1316	1286	1266	1246
Art.-Nr.	267121504	267121504	267121504	267121504	267121504

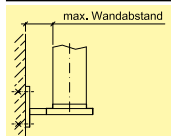

Befestigungsmaterial bauseits (untergrundabhängig)

*WA = Wandabstand

Maße in mm

SCHIEDEL ICS
Lieferprogramm (Stand 2010)

*Lieferzeit 10 Arbeitstage

200	230	250	300	350*	400*	450*	500*	600*	700*
266000120	266000123	266000125	266000130	266000135	266000140	266000145	266000150	266000160	266000170
4,86	5,73	6,26	7,79	9,35	10,57	11,94	13,49	17,23	19,47
95	95	95	95	95	95	95	95	95	95
370	400	420	475	500	550	600	650	750	850
266000220	266000223	266000225	266000230	266000235	266000240	266000245	266000250	266000260	266000270
4,51	5,38	5,69	7,01	8,44	—	—	—	—	—
1045	1045	1045	1045	1045	1045	1045	1045	1045	1045
160	160	160	160	160	160	160	160	160	160
296	326	346	401	419	469	519	569	669	769
266000420	266000423	266000425	266000430	266000435	266000440	266000445	266000450	266000460	266000470
4,86	5,73	6,26	7,79	9,35	10,75	10,84	12,58	16,44	20,79
97	97	97	97	97	97	97	97	97	97
285	315	335	385	435	485	535	585	685	785
353	383	403	453	503	553	603	653	753	853
140	155	165	190	215	240	265	290	340	390
266000820	266000823	266000825	266000830	266000835	266000840	266000845	266000850	266000860	266000870
8,64	9,20	9,86	11,21	12,42	26,73	29,16	31,52	36,33	41,16
279	309	329	379	429	479	529	579	679	779
347	377	397	447	497	547	597	647	747	847
300-500	300-500	300-500	300-500	300-500	300-500	300-500	300-500	300-500	300-500
266000620	266000623	266000625	266000630	266000635	266000640	266000645	266000650	266000660	266000670
3,54	3,61	3,72	4,00	5,40	7,58	8,20	11,20	19,14	21,48
315	345	365	415	465	515	565	615	715	815
470	470	470	470	670	670	670	870	870	870
200	230	250	300	350	400	450	500	600	700
—	—	—	—	—	—	—	—	—	—
—	—	—	—	—	—	—	—	—	—
207	177	157	107	—	—	—	—	—	—
267120475	267120475	267120475	267120475	—	—	—	—	—	—
302	272	252	202	152	102	—	—	—	—
267120570	267120570	267120570	267120570	267120570	267120570	—	—	—	—
452	422	402	352	302	252	202	152	—	—
267120720	267120720	267120720	267120720	267120720	267120720	267120720	267120720	—	—
552	522	502	452	402	352	302	252	152	—
267120820	267120820	267120820	267120820	267120820	267120820	267120820	267120820	267120820	—
736	706	686	636	586	536	486	436	336	236
267121004	267121004	267121004	267121004	267121004	267121004	267121004	267121004	267121004	267121004
852	822	802	752	702	652	602	552	452	352
267121120	267121120	267121120	267121120	267121120	267121120	267121120	267121120	267121120	267121120
1036	1006	986	936	886	836	786	736	636	536
267121304	267121304	267121304	267121304	267121304	267121304	267121304	267121304	267121304	267121304
1236	1206	1186	1136	1086	1036	986	936	836	736
267121504	267121504	267121504	267121504	267121504	267121504	267121504	267121504	267121504	267121504

ICS

SCHIEDEL ICS
Lieferprogramm (Stand 2010)

Lichter Ø **80** **100** **130** **150** **180**

1g

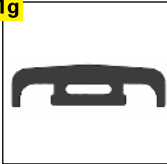

Regenabdeckung für Montageschienen

aus Kunststoff
für Pos. 1f

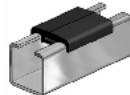

Art.-Nr.	265400201	265400201	265400201	265400201	265400201
Länge	100 cm	100 cm	100 cm	100 cm	100 cm

- zusätzliche Abdichtung zur Wand hin erforderlich

1h



SET-Wandkonsole + Bogen 85° (inkl. Klemmband)

für Abgas-
leitungen

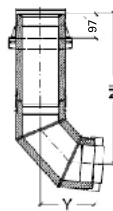

Art.-Nr.	025660008	025660010	025660013	025660015	025660018
Gewicht kg/Stk.	3,92	4,67	5,85	6,67	8,05
Nutzlänge (NL)	557	555	567	586	583
Y	153	151	163	182	179

Set bestehend aus: Zwischenstützen, Rohrelement 250, Bogen 85°

Montageschiene (Pos. 1f) noch erforderlich

1i



Zwischenstütze

- als Statische Komponente
(s. Statischer Planungshinweis)
- als Rußstopflösung in
Verbindung mit Pos. 1j

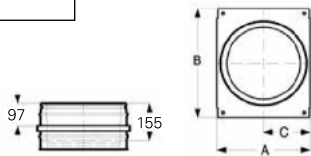

Art.-Nr.	266001008	266001010	266001013	266001015	266001018
Gewicht kg/Stk.	1,75	2,02	2,43	2,70	3,12
Nutzlänge (NL)	155	155	155	155	155
A	185	205	235	255	275
B	250	270	300	320	350
C	80	90	105	115	130

1j



Kondensatschale mit Ablauf

für Rußstopflösung in
Verbindung mit Pos. 1i

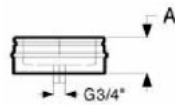

Art.-Nr.	266000508	266000510	266000513	266000515	266000518
Gewicht kg/Stk.	1,01	1,36	1,70	1,94	2,33
A	95	95	95	95	95

1k



Grundplatte für Kaminverlängerung

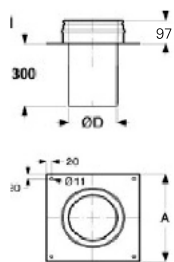

Art.-Nr.	266000308	266000310	266000313	266000315	266000318
Gewicht kg/Stk.	2,36	2,77	3,38	3,79	4,40
Nutzlänge (NL)	97	97	97	97	97
A	250	270	300	320	350
ØD (außen)	75	95	125	145	175

- zum Verlängern von besteh. alten Kaminsystemen

- Befestigung bauseits

- Unterdruck, FE

2a



Putzanschluss Festbrennstoff (inkl. Klemmband)

Stützen nicht verlängerbar

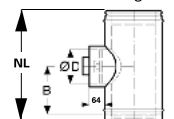

Art.-Nr.	236900308	236900310	236900313	236900315	236900318
Gewicht kg/Stk.	1,97	2,27	1,76	2,21	2,46
Nutzlänge (NL)	288	288	288	305	305
B	121	121	121	130	130
ØD	80	100	130	150	150

Maße in mm

SCHIEDEL ICS
Lieferprogramm (Stand 2010)

*Lieferzeit 10 Arbeitstage

200	230	250	300	350*	400*	450*	500*	600*	700*
265400201	265400201	265400201	265400201	265400201	265400201	265400201	265400201	265400201	265400201
100 cm	100 cm	100 cm	100 cm	100 cm	100 cm	100 cm	100 cm	100 cm	100 cm

025660020	025660023	025660025	025660030	025660035	025660040	025660045	025660050	025660060	025660070
8,83	10,01	11,16	13,69	16,80	21,50	24,71	28,28	35,98	44,47
589	603	612	636	662	747	771	796	845	894
185	199	208	232	258	349	373	398	447	496

266001020	266001023	266001025	266001030	266001035	266001040	266001045	266001050	266001060	266001070
3,40	3,84	4,12	4,93	6,10	7,35	8,51	9,61	11,97	14,52
155	155	155	155	155	155	155	155	155	155
285	315	335	385	435	485	535	585	685	785
353	383	403	453	503	553	603	653	753	853
140	155	165	190	215	240	265	290	340	390

266000520	266000523	266000525	266000530	266000535	266000540	266000545	266000550	266000560	266000570
2,61	3,10	3,36	4,09	4,70	5,09	5,24	5,58	6,52	8,23
35	35	35	35	35	35	35	35	35	35

266000320	266000323	266000325	266000330	266000335	266000340	266000345	266000350	266000360	266000370
4,82	5,47	5,87	6,98	8,07	9,11	10,80	12,60	16,50	20,80
37	37	37	37	37	37	37	37	37	37
370	400	420	475	525	575	625	675	775	875
195	225	245	295	345	395	445	495	595	695

236900320	236900323	236900325	236900330	236900335	236900340	236900345	236900350	236900360	236900370
4,19	4,58	6,88	7,73	9,16	11,33	12,36	13,40	15,48	17,60
405	405	455	455	535	705	705	705	705	705
180	180	205	205	253	330	330	330	330	330
200	200	250	300	300	300	300	300	300	300

SCHIEDEL ICS
Lieferprogramm (Stand 2010)

*Lieferzeit 10 Arbeitstage

200	230	250	300	350*	400*	450*	500*	600*	700*
236900020	236900023	236900025	236900030	236900035	236900040	236900045	236900050	236900060	236900070
4,19	4,58	6,88	7,73	9,16	11,33	12,36	13,40	15,48	17,60
405	405	455	455	535	705	705	705	705	705
180	180	205	205	253	330	330	330	330	330
200	200	250	300	300	300	300	300	300	300

231409020	231409023	231409025	231409030	231409035	231409040	231409045	231409050	231409060	231409070
5,04	6,04	6,56	7,90	10,39	13,36	15,51	18,70	23,50	31,44
455	455	455	480	530	605	655	705	805	955
209	209	209	222	247	285	310	335	385	435
165	180	190	205	240	280	305	330	380	430

231408520	231408523	231408525	231408530	231408535	231408540	231408545	231408550	231408560	231408570
5,04	6,04	6,56	7,90	10,39	12,81	15,77	19,01	23,94	32,02
455	455	455	480	530	605	655	705	805	905
240	240	235	246	270	304	332	359	414	469
176	215	220	234	260	305	330	355	415	470

236900020	236900623	236900625	236900630	—	—	—	—	—	—
5,64	6,40	7,34	7,90						
455	455	455	485						
206	206	206	228						
165	180	190	215						
150	150	150	200						

236900720	236900723	236900725	236900730	—	—	—	—	—	—
5,64	6,40	7,34	7,90						
455	455	455	485						
206	206	206	228						
165	180	190	215						
150	150	150	200						

231404520	231404523	231404525	231404530	231404535	231404540	231404545	231404550	231404560	231404570
6,80	7,79	8,61	11,53	14,78	19,52	21,49	26,09	36,86	48,94
530	530	560	623	697	815	885	955	1100	1245
378	393	413	472	530	615	675	735	855	980
376	390	410	469	530	615	675	735	855	955

266040020	266040023	266040025	266040030	266040035	266040040	266040045	266040050	266040060	266040070
1,04	1,19	1,28	1,51	1,77	2,05	3,04	3,35	3,97	4,59
150	150	150	150	150	150	150	150	150	150

SCHIEDEL ICS
Lieferprogramm (Stand 2010)

Lichter Ø	80	100	130	150	180
-----------	----	-----	-----	-----	-----

3g



Anschlussübergang mit Doppelwandfutter

passend auf Pos. 3a-3e
Übergang auf Ofenrohr
bzw. Fremdrohr
(als Verbindungsleitung)

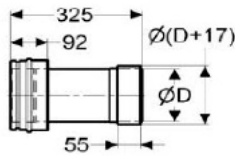

Lichter Ø mm	100	130	150	150	180
Art.-Nr.	266021010	266021313	266021513	266021515	266021815
Gewicht kg/Stk.	1,20	1,30	1,41	1,49	1,67
ICS Nenn-Ø	100	130	150	150	180
für Ofenrohr-Ø	100	130	130	150	150
ØD (außen)	93	123	123	143	143

3h



Anschlussübergang Prima Plus auf ICS-Verbindungsleitung

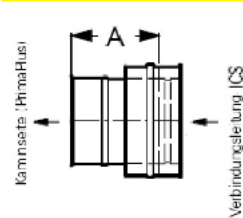

Art.-Nr.	266041008	266041010	266041013	266041015	266041018
Gewicht kg/Stk.	0,47	0,57	0,71	0,81	0,95
A	155	155	155	155	155

passend auf Prima Plus - Anschluss glatt;
Übergang v. Prima Plus (Kamin) auf ICS-Verbind.leitung

3i



Verschlussdeckel

passend auf
Pos. 3a-3e für
nicht betriebene
Rauchrohran-
schlüsse
(T-Stück)

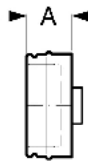

Art.-Nr.	266002008	266002010	266002013	266002015	266002018
A	95	95	95	95	95

Lichter Ø	100	113	120	130	140
Kaminseite (Muffe)					

4a



Reduktionen/Erweiterungen

Baulänge: 150mm

-passend auf Anschlussüber-
gang Pos. 3f
- Klemmband mitbestellen
(Artikel siehe Prima Plus)
- weitere Red./Erweit. und
exzentrische Red./Erweit.
siehe bei Prima Plus

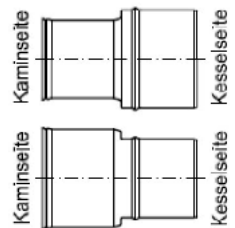

Kesselseite Ø80					
Art.-Nr.	267250810	267250811	267250812	267250813	—
Kesselseite Ø100					
Art.-Nr.	—	267251011	267251012	267251013	267251014
Kesselseite Ø113					
Art.-Nr.	267201110	—	267251112	267251113	267251114
Kesselseite Ø120					
Art.-Nr.	267201210	267201211	—	267251213	267251214
Kesselseite Ø130					
Art.-Nr.	267201310	267201311	267201312	—	267251314
Kesselseite Ø150					
Art.-Nr.	—	—	267201512	267201513	267201514
Kesselseite Ø160					
Art.-Nr.	—	—	—	267201613	267201614
Kesselseite Ø180					
Art.-Nr.	—	—	—	267201813	267201814
Kesselseite Ø200					
Art.-Nr.	—	—	—	—	—
Kesselseite Ø230					
Art.-Nr.	—	—	—	—	—
Kesselseite Ø250					
Art.-Nr.	—	—	—	—	—
Kesselseite Ø300					
Art.-Nr.	—	—	—	—	—

Maße in mm

SCHIEDEL ICS
Lieferprogramm (Stand 2010)

*Lieferzeit 10 Arbeitstage

200	230	250	300	350*	400*	450*	500*	600*	700*
180	200	200							
266021818	266022018	266022020							
1,81	1,92	2,03							
180	200	200							
180	180	200							
173	173	193							

266041020	266041023	266041025	266041030	266041035	266041040	266041045	266041050	266041060	266041070
1,04	1,19	1,28	1,51	1,72	1,88	2,89	3,19	3,78	4,37
155	155	155	155	155	155	155	155	155	155

266002020	266002023	266002025	266002030	266002035	266002040	266002045	266002050	266002060	266002070
95	95	95	95	95	95	95	95	95	95

150	160	180	200	230	250	300	350	400
Kaminseite (Muffe)								
–	–	–	–	–	–	–	–	–
267251015	–	–	–	–	–	–	–	–
267251115	–	–	–	–	–	–	–	–
267251215	–	–	–	–	–	–	–	–
267251315	267251316	267251318	–	–	–	–	–	–
–	267251516	267251518	267251520	–	–	–	–	–
267201615	–	267251618	267251620	–	–	–	–	–
267201815	267201816	–	267251820	267251823	267251825	–	–	–
267202015	267202016	267202018	–	267252023	267252025	–	–	–
–	–	267202318	267202320	–	267252325	–	–	–
–	–	267202518	267202520	267202523	–	267252530	–	–
–	–	–	–	–	267253025	–	267253035	267253040

SCHIEDEL ICS
Lieferprogramm (Stand 2010)

Lichter Ø **80** **100** **130** **150** **180**

4b



Kesselanschluss Öl, Gas

aus Edelstahl
mit Dichtung
und
thermischer
Trennung

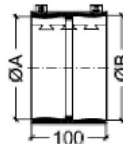

Art.-Nr.	—	265000110	265000113	265000115	265000118
Gewicht kg/Stk.	—	0,60	0,70	0,80	0,90
ØA max.	—	103	133	153	183
ØB max.	—	105	135	155	185

- Temperaturgrenze 200°C, weitere Durchmesser siehe bei Prima Plus
- Reduziermöglichkeit um 1 Durchmesser → halbes Silikonband einlegen (siehe Zubehör)

4c



Kesselanschluss Festbrennstoff

aus Edelstahl
mit Vlies

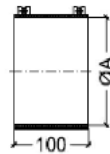

Art.-Nr.	265000508	265000510	265000513	265000515	265000518
Gewicht kg/Stk.	0,50	0,60	0,70	0,80	0,90
ØA max.	83	103	133	153	183

- Temperaturgrenze 200°C, weitere Durchmesser siehe bei Prima Plus
- Reduziermöglichkeit um 1 Durchmesser → doppeltes Einlegen einer Bandhälfte

4d



Ignis Protect

für Wanddurchführungen
aus brennbaren Bauteilen

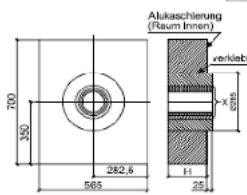

X - Rohrschalen in Ø 113,
Ø 133, Ø 153, Ø 185

ACHTUNG: geprüft und einzusetzen bis Ø180

Art.-Nr.	Wandstärke - H	Gewicht/kg
271000100	100	4,00
271000150	150	6,00
271000200	200	8,40
271000250	250	10,50
271000300	300	12,50
271000350	350	15,00
271000400	400	16,70

ACHTUNG: Aluminiumkaschierung an die Rauminnenseite; Rohrschalen herausziehbar. Material: zugelassene Mineralwolle, Rohdichte: 120 kg/m³, Baustoffklasse A nach DIN 4102. Die Breite entspricht dem Rastermaß von Holzständerwänden

4e

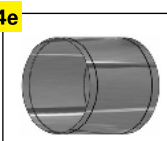

Hüllrohr für Wanddurchführung

für Wanddurchführung aus
brennbaren
Bauteilen
(Alternativ zu
Ignis Protect)



Art.-Nr.	265703018	265703018	265703018	265703018	265703020
ØA	500	500	500	500	550

Materialstärke 0,4mm; Edelstahl 1.4301

5a



Rohrelement 955 (inkl. Klemmband)



Art.-Nr.	142010008	142010010	142010013	142010015	142010018
Gewicht kg/Stk.	3,99	4,73	5,84	6,58	7,69
Nutzlänge (NL)	955	955	955	955	955
Außen Ø	130	150	180	200	230

5b



Rohrelement 455 (inkl. Klemmband)

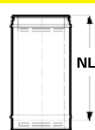

Art.-Nr.	142005008	142005010	142005013	142005015	142005018
Gewicht kg/Stk.	1,98	2,34	2,89	3,26	3,8
Nutzlänge (NL)	455	455	455	455	455
Außen Ø	130	150	180	200	230

5c



Rohrelement 205 (inkl. Klemmband)

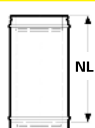

Art.-Nr.	142002508	142002510	142002513	142002515	142002518
Gewicht kg/Stk.	0,97	1,15	1,42	1,59	1,86
Nutzlänge (NL)	205	205	205	205	205
Außen Ø	130	150	180	200	230

Maße in mm

SCHIEDEL ICS
Lieferprogramm (Stand 2010)

*Lieferzeit 10 Arbeitstage

	200	230	250	300	350*	400*	450*	500*	600*	700*
265000120	—		265000125	265000130	—	—	—	—	—	—
1,00		1,20	1,30							
203		253	305							
205		255	307							
265000520	—		265000525	265000530	—	—	—	—	—	—
1,00		1,20	1,30							
203		253	305							
265703020	265703025	265703025	—	—	—	—	—	—	—	—
550	600	600								
142010020	142010023	142010025	142010030	142010035	142010040	142010045	142010050	142010060	142010070	
8,43	9,56	10,28	12,08	13,96	15,81	19,1	21,1	25,09	29,07	
955	955	955	955	955	955	955	955	955	955	955
250	280	300	350	400	450	500	550	650	750	
142005020	142005023	142005025	142005030	142005035	142005040	142005045	142005050	142005060	142005070	
4,17	4,73	5,09	5,97	6,9	7,82	9,42	10,41	12,38	14,34	
455	455	455	455	455	455	455	455	455	455	455
250	280	300	350	400	450	500	550	650	750	
142002520	142002523	142002525	142002530	142002535	142002540	142002545	142002550	142002560	142002570	
2,04	2,31	2,49	2,92	3,37	3,82	4,59	5,07	6,01	6,97	
205	205	205	205	205	205	205	205	205	205	205
250	280	300	350	400	450	500	550	650	750	

SCHIEDEL ICS
Lieferprogramm (Stand 2010)

Lichter Ø **80** **100** **130** **150** **180**

5d



Rohrelement 155 (inkl. Klemmband)

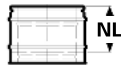

Art.-Nr.	142002008	142002010	142002013	142002015	142002018
Gewicht kg/Stk.	0,77	0,91	1,12	1,26	1,47
Nutzlänge (NL)	155	155	155	155	155
Außen Ø	130	150	180	200	230

5e



Dichtring aus Silikon

für Überdruckbetrieb
bei **Gasfeuerung**
je Element 1 Stk. erforderlich

Art.-Nr.	270301008	270301010	270301013	270301015	270301018
Farbe der Dichtung: schwarz - ACHTUNG: Einfetten der Dichtringe mit Kunststoffgleitmittel erforderlich					

5f

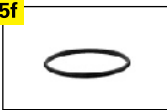

Dichtring aus Viton

für Überdruckbetrieb
bei **Öl-, Gasfeuerung**
je Element 1 Stk. erforderlich

Art.-Nr.	270301208	270301210	270301213	270301215	270301218
Farbe der Dichtung: braun - ACHTUNG: Einfetten der Dichtringe mit Kunststoffgleitmittel erforderlich					

5g



Kunststoffgleitmittel

zum Einfetten der Dichtringe
für Überdruck
Inhalt: 150ml

Art.-Nr.	026500001	026500001	026500001	026500001	026500001

6a



Wandhalter

Wandabstand: 50 mm
- mind. alle 4 m setzen
- zu verlängern mit Pos. 6b, 6c

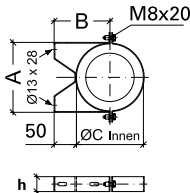

Art.-Nr.	267150130	267150150	267150180	267150200	267150230
Gewicht kg/Stk.	0,44	0,48	0,53	0,58	0,64
ØC innen	131,1	151,1	181,1	201,1	231,1
A	138	158	188	208	238
B	116	126	141	151	166
h	36	36	36	36	36

Befestigungsmaterial bauseits (untergrundabhängig)

6b



Verlängerung Wandhalter klein

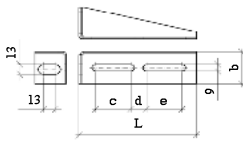

mind. WA* bei "Typ W1"	55	55	55	55	55
max. WA* bei "Typ W1"	100	100	100	100	100
Art.-Nr.	267100130	267100130	267100130	267100130	267100130
max. WA* bei "Typ W2"	—	—	—	—	—
Art.-Nr.	—	—	—	—	—
max. WA* bei "Typ W3"	—	—	—	—	—
Art.-Nr.	—	—	—	—	—

*WA = Wandabstand

passend zu Wandhalter (6a) - Befestigungsmaterial bauseits - (untergrundabhängig)

Typ	L	c	d	e	b
W1	130	50	16	35	36
W2	176	60	25	60	36
W3	250	65	88	65	60

6c



Verlängerung Wandhalter

passend zu Wandhalter (6a)
Befestigungsmaterial bauseits
(untergrundabhängig)

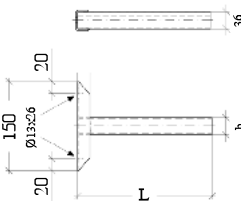

mind. WA* bei "Typ L1"	100	100	100	100	100
max. WA* bei "Typ L1"	250	250	250	250	250
Art.-Nr.	267100300	267100300	267100300	267100300	267100300
max. WA* bei "Typ L2"	440	440	440	440	440
Art.-Nr.	267100450	267100450	267100450	267100450	267100450
max. WA* bei "Typ L3"	500	500	500	500	500
Art.-Nr.	267100550	267100550	267100550	267100550	267100550
max. WA* bei "Typ L4"	700	700	700	700	700
Art.-Nr.	267100750	267100750	267100750	267100750	267100750

*WA = Wandabstand

Regenabdeckung (siehe Pos. 1g) bei Vollwärmeschutz verwenden

Maße in mm

Typ	L	b
L1	300	32
L2	450	32
L3	550	42
L4	750	42

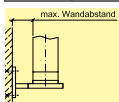

SCHIEDEL ICS
Lieferprogramm (Stand 2010)

*Lieferzeit 10 Arbeitstage

200	230	250	300	350*	400*	450*	500*	600*	700*
142002020	142002023	142002025	142002030	142002035	142002040	142002045	142002050	142002060	142002070
1,61	1,83	1,97	2,31	2,67	3,02	4,79	5,25	6,59	7,37
155	155	155	155	155	155	155	155	155	155
250	280	300	350	400	450	500	550	650	750
270301020	270301023	270301025	270301030	270301035	270301040	270301045	270301050	270301060	270301070
270301220	270301223	270301225	270301230	270301235	—	—	—	—	—
026500001	026500001	026500001	026500001	026500001	026500001	026500001	026500001	026500001	026500001
267150250	267150280	267150300	267150350	267150400	267150450	267150500	267150550	267150650	267150750
0,70	0,64	0,79	0,85	1,33	1,60	1,96	2,09	3,20	4,00
251,1	281,1	301,1	350,4	400,4	450,4	500,5	550,5	650,5	750,4
258	288	308	358	412	462	512	562	662	762
176	191	201	225	250	275	300	325	375	425
36	36	36	60	60	30	30	60	60	60
—	—	—	—	—	—	—	—	—	—
—	—	—	—	—	—	—	—	—	—
—	—	—	—	—	—	—	—	—	—
114	114	114	114	—	—	—	—	—	—
267100176	267100176	267100176	267100176	—	—	—	—	—	—
—	—	—	—	122	122	122	122	122	122
—	—	—	—	267100250	267100250	267100250	267100250	267100250	267100250
100	100	100	100	100	100	100	100	100	100
250	250	220	220	160	160	160	160	160	160
267100300	267100300	267100300	267100300	267100300	267100300	267100300	267100300	267100300	267100300
440	440	370	370	310	310	310	310	310	310
267100450	267100450	267100450	267100450	267100450	267100450	267100450	267100450	267100450	267100450
500	500	470	470	410	410	410	410	410	410
267100550	267100550	267100550	267100550	267100550	267100550	267100550	267100550	267100550	267100550
700	700	670	670	610	610	610	610	610	610
267100750	267100750	267100750	267100750	267100750	267100750	267100750	267100750	267100750	267100750

ICS

SCHIEDEL ICS

Lieferprogramm (Stand 2010)

Lichter Ø **80** **100** **130** **150** **180**

6d

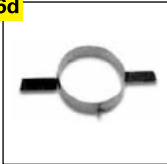

Sparrenhalter

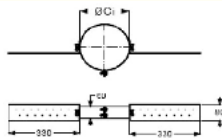

Art.-Nr.	265405008	265405010	265405013	265405015	265405018
Gewicht kg/Stk.	1,00	1,10	1,22	1,25	1,30
Ø Ci	130	150	180	200	230

auch als Deckenhalter verwendbar

7a



Dachdurchführung 0° (in Edelstahl)

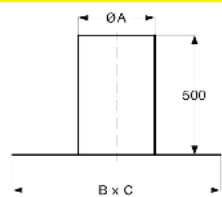

Art.-Nr.	266320200	266320200	266320250	266320250	266320300
Gewicht kg/Stk.	3,86	3,86	4,59	4,59	5,34
ØA	200	200	250	250	300
B x C	700	700	750	750	800

7b



Dachdurchführung 3°-15° (mit Bleischürze)

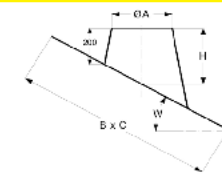

Art.-Nr.	266321200	266321200	266321250	266321250	266321300
Gewicht kg/Stk.	10,83	10,83	13,50	13,50	14,56
ØA	200	200	250	250	300
H	224	224	228	228	233
B x C	830 x 830	830 x 830	880 x 880	880 x 880	940 x 940

7c



Dachdurchführung 16° - 25° (mit Bleischürze)

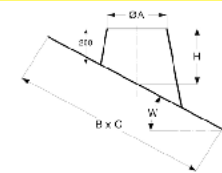

Art.-Nr.	266322200	266322200	266322250	266322250	266322300
Gewicht kg/Stk.	11,25	11,25	14,13	14,13	15,24
ØA	200	200	250	250	300
H	249	249	258	258	267
B x C	850 x 830	850 x 830	910 x 880	910 x 880	970 x 940

7d



Dachdurchführung 26°-35° (mit Bleischürze)

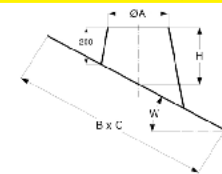

Art.-Nr.	266323200	266323200	266323250	266323250	266323300
Gewicht kg/Stk.	12,11	12,11	15,16	15,16	16,33
ØA	200	200	250	250	300
H	278	278	293	293	307
B x C	900 x 830	900 x 830	960 x 880	960 x 880	1020 x 940

7e



Dachdurchführung 36°-45° (mit Bleischürze)

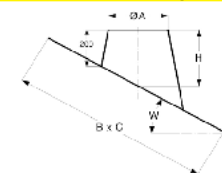

Art.-Nr.	266324200	266324200	266324250	266324250	266324300
Gewicht kg/Stk.	13,35	13,35	16,93	16,93	18,51
ØA	200	200	250	250	300
H	314	314	334	334	355
B x C	960 x 830	960 x 830	1040 x 880	1040 x 880	1120 x 940

7f



Regenkragen inkl. Dichtband

oberhalb der Dachdurchführung über Kerastarrohr versetzen, zur Abdeckung des Ringspaltes

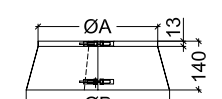

Art.-Nr.	265830130	265830150	265830180	265830200	265830230
Gewicht kg/Stk.	0,29	0,31	0,35	0,38	0,39
Ø A	130	150	180	200	230
Ø B	270	290	320	340	370

Maße in mm

SCHIEDEL ICS
Lieferprogramm (Stand 2010)

*Lieferzeit 10 Arbeitstage

200	230	250	300	350*	400*	450*	500*	600*	700*
265405020	265405023	265405025	265405030	—	—	—	—	—	—
1,33	1,37	1,40	1,47						
250	280	300	350						

266320300	266320350	266320350	266320400	266320450	266320500	266320550	266320600	266320700	266320800
5,34	6,11	6,11	6,90	7,72	8,57	9,44	10,33	12,19	14,14
300	350	350	400	450	500	550	600	700	800
800	850	850	900	950	1000	1050	1100	1200	1300

266321300	266321350	266321350	266321400	266321450	266321500	266321550	266321600	266321700	266321800
14,56	15,48	15,48	18,61	19,82	20,71	23,62	25,64	29,90	34,50
300	350	350	400	450	500	550	600	700	800
233	237	237	241	246	250	255	259	268	277
940 x 940	990 x 990	990 x 990	1040 x 1040	1100 x 1100	1100 x 1150	1200 x 1250	1250 x 1300	1350 x 1400	1450 x 1500

266322300	266322350	266322350	266322400	266322450	266322500	266322550	266322600	266322700	266322800
15,24	16,20	16,20	19,61	20,86	22,12	24,99	27,09	31,93	37,16
300	350	350	400	450	500	550	600	700	800
267	277	277	268	295	304	313	322	340	358
970 x 940	1020 x 990	1020 x 990	1080 x 1040	1100 x 1100	1200 x 1150	1250 x 1250	1300 x 1300	1420 x 1400	1540 x 1500

266323300	266323350	266323350	266323400	266323450	266323500	266323550	266323600	266323700	266323800
16,33	17,64	17,64	21,26	22,74	24,07	27,48	29,91	35,26	41,05
300	350	350	400	450	500	550	600	700	800
307	321	321	336	350	365	379	394	422	451
1020 x 940	1090 x 990	1090 x 990	1150 x 1040	1100 x 1100	1280 x 1150	1350 x 1250	1410 x 1300	1540 x 1400	1670 x 1500

266324300	266324350	266324350	266324400	266324450	266324500	266324550	266324600	266324700	266324800
18,51	19,95	19,95	24,24	25,86	27,66	31,59	34,46	40,75	47,76
300	350	350	400	450	500	550	600	700	800
355	376	376	397	418	439	460	481	523	565
1120 x 940	1190 x 990	1190 x 990	1270 x 1040	1100 x 1100	1420 x 1150	1500 x 1250	1570 x 1300	1720 x 1400	1880 x 1500

265830250	265830280	265830300	265830350	265830400	265830450	265830500	265830550	265830650	265830750
0,45	0,48	0,51	0,85	0,95	1,05	1,15	1,25	1,45	1,66
250	280	300	350	400	450	500	550	650	750
390	420	440	490	540	590	640	690	790	900

SCHIEDEL ICS
Lieferprogramm (Stand 2010)

*Lieferzeit 10 Arbeitstage

200	230	250	300	350*	400*	450*	500*	600*	700*
266200020	266200023	266200025	266200030	266200035	266200040	266200045	266200050	266200060	266200070
1,91	2,17	2,34	2,76	3,20	3,63	3,93	4,34	5,16	5,98
205	205	205	205	205	205	205	205	205	205

025300820	025300823	025300825	025300830	—	—	—	—	—	—
1,27	1,50	1,61	1,96						
195	224	244	294						
380	410	430	480						
180	250	250	250						

—	—	—	—	260200535	260200540	260200545	260200550	260200560	260200570
				2,16	4,92	6,11	7,37	7,57	7,71
				175	200	225	250	300	350
				700	800	900	1000	1000	1000

265404725	265404728	265404730	265404735	—	—	—	—	—	—
0,49	0,52	0,54	0,59						
250	280	300	350						
420	450	470	520						

265404125	265404128	265404130	265404135	—	—	—	—	—	—
2,06	2,16	2,36	2,69						
250	280	300	350						
690	720	740	790						

265404720	265404723	265404725	265404730	—	—	—	—	—	—
0,45	0,49	0,52	0,58						
200	230	250	300						
370	400	420	470						

265401120	265401123	265401125	265401130	—	—	—	—	—	—
0,18	0,25	0,30	0,60						
260	290	310	360						

ICS

SCHIEDEL ICS
Lieferprogramm (Stand 2010)

Lichter Ø 80 100 130 150 180

10a



Zugbegrenzer mit Explosionsklappe

Einbau in den Anschlussübergang Pos.3f; je nach Ø einen „Adapter für Zugbegrenzer“ od. eine „Erweiterung“ verwenden

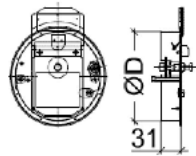

Art.-Nr.	80	100	130	150	180
—	255300001	255300001	255300001	255300001	255300002
Gewicht kg/Stk.	0,70	0,70	0,70	0,70	1,05
ØD (außen)	129,3	129,3	129,3	129,3	179,3
Ø100: in Verbindung mit einer Reduzierung 13/10 - Art.Nr.: 267201310					
Ø150: in Verbindung mit einer Erweiterung 13/15 - Art.Nr.: 267251315					
Ø230: in Verbindung mit einer Erweiterung 18/23 - Art. Nr.: 267251823					
Ø200, Ø250: in Verbindung mit dem „Adapter für Zugbegrenzer“ - siehe Pos. 10b					

10b



Adapter für Zugbegrenzer

passend zu Zugbegrenzer

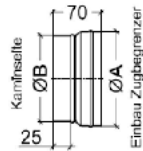

Art.-Nr.	80	100	130	150	180
—	—	—	—	—	—
Gewicht kg/Stk.					
ØA (innen)					
ØB (außen)					
H					

10c



Zugbegrenzer mit Explosionsklappe Ø300

Einbau in den Anschlussübergang Pos.3f; für Ø350, Ø400 entsprech. Erweiterungen verwenden

Art.-Nr.	80	100	130	150	180
—	—	—	—	—	—
Gewicht kg/Stk.					

11a



Statisches Klemmband

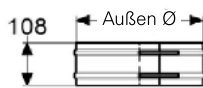

Art.-Nr.	80	100	130	150	180
266002308	266002310	266002313	266002315	266002318	
Gewicht kg/Stk.	0,29	0,32	0,36	0,38	0,43
Außen Ø	130	150	180	200	230

ab 1,5m freistehend erforderlich, ab Ø350 standardmäßig bei jedem Rohrelement enthalten; Anwendung je Ø siehe Statischer Planungshinweis

11b



Seilabspannung (für Abspannungen über Dach)

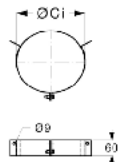

Art.-Nr.	80	100	130	150	180
95900130	95900150	95900180	95900200	95900230	
Gewicht kg/Stk.	0,44	0,47	0,5	0,54	0,58
Ø Ci	130	150	180	200	230

Stahlseile, Befestigungsmaterial werden nicht mitgeliefert

12

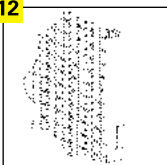

Berührungsgitter

bei Festbrennstoffbetrieb erforderlich - dort, wo der Kamin berührt werden kann

Art.-Nr.	80	100	130	150	180
265401202	265401202	265401202	265401202	265401202	265401202

Grundrisskizze erforderlich

13



Reinigungsset Edelstahl

1 Paste
1 Cleaner
10 Saugtücher

Art.-Nr.	80	100	130	150	180
270300304	270300304	270300304	270300304	270300304	270300304

Maße in mm

SCHIEDEL ICS
Lieferprogramm (Stand 2010)

*Lieferzeit 10 Arbeitstage

200	230	250	300	350*	400*	450*	500*	600*	700*
255300002	255300002	255300002	—	—	—	—	—	—	—
1,05	1,05	1,05							
179,3	179,3	179,3							

265051820	—	265051825	—	—	—	—	—	—	—
0,15		0,25							
180		180							
193		242							
70		70							

—	—	—	025301030	025301030	025301030	—	—	—	—
			4,62	4,62	4,62				
				Erweiterung 267253035 verwenden	Erweiterung 267253035 verwenden				

266002320	266002323	266002325	266002330	← standardmäßig bei jedem Rohrelement enthalten →					
0,45	0,49	0,52	0,59						
250	280	300	350						

95900250	95900280	95900300	95900350	95900400	95900450	95900500	95900550	95900650	95900750
0,61	0,58	0,68	0,49	0,5	0,5	0,6	0,7	0,9	1,22
250	280	300	350	400	450	500	550	650	750

265401202	265401202	265401202	265401202	265401202	265401202	265401202	265401202	265401202	265401202
------------------	------------------	------------------	------------------	------------------	------------------	------------------	------------------	------------------	------------------

270300304	270300304	270300304	270300304	270300304	270300304	270300304	270300304	270300304	270300304
------------------	------------------	------------------	------------------	------------------	------------------	------------------	------------------	------------------	------------------

ICS

SCHIEDEL ICS
Lieferprogramm (Stand 2010)

Lichter Ø **80** **100** **130** **150** **180**

14a



Bogen 15°

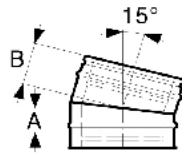

Art.-Nr.	142031508	142031510	142031513	142031515	142031518
Gewicht kg/Stk.	0,74	0,88	1,08	1,22	1,43
A	57	57	57	57	57
B	92	92	102	102	102

14b



Bogen 30°

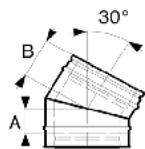

Art.-Nr.	142033008	142033010	142033013	142033015	142033018
Gewicht kg/Stk.	0,74	0,88	1,08	1,22	1,81
A	57	57	57	57	82
B	102	102	107	112	117

Zubehör für Verbindungsleitung

V1



Bogen 45°

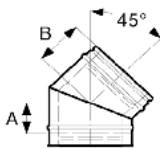

Art.-Nr.	142034508	142034510	142034513	142034515	142034518
Gewicht kg/Stk.	0,93	1,11	1,37	1,54	1,81
A	82	82	82	82	82
B	117	117	127	127	132

V2



Bogen 85°

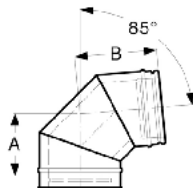

Art.-Nr.	142038508	142038510	142038513	142038515	142038518
Gewicht kg/Stk.	1,20	1,50	2,00	2,38	3,07
A	153	151	163	182	179
B	197	195	207	226	223

V3



Bogen 85° mit Revisionsverschluss für Festbrennstoff

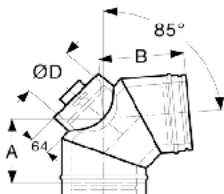

Art.-Nr.	142038808	142038810	142038813	142038815	142038818
Gewicht kg/Stk.	1,61	2,02	2,68	3,05	3,68
A	153	151	163	182	179
B	197	195	207	226	223
ØD	80	100	130	150	150

V4



Bogen 85° mit Revisionsverschluss für Öl, Gas

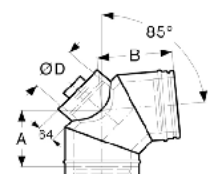

Art.-Nr.	142038708	142038710	142038713	142038715	142038718
Gewicht kg/Stk.	1,61	2,02	2,68	3,05	3,68
A	153	151	163	182	179
B	197	195	207	226	223
ØD	80	100	130	150	150

Maße in mm

SCHIEDEL ICS
Lieferprogramm (Stand 2010)

*Lieferzeit 10 Arbeitstage

200	230	250	300	350*	400*	450*	500*	600*	700*
142031520	142031523	142031525	142031530	142031535	142031540	142031545	142031550	142031560	142031570
1,57	1,78	1,91	2,25	2,87	3,25	5,55	6,13	7,54	9,41
57	57	57	57	57	87	92	97	107	119
102	102	102	102	112	131	136	141	151	163

142033020	142033023	142033025	142033030	142033035	142033040	142033045	142033050	142033060	142033070
1,98	2,25	2,42	2,84	4,42	5,00	6,72	7,63	9,83	11,98
32	82	82	32	123	122	127	132	147	162
117	127	127	132	159	166	171	176	191	206

142034520	142034523	142034525	142034530	142034535	142034540	142034545	142034550	142034560	142034570
2,15	2,53	2,82	3,83	4,42	5,00	7,88	9,13	11,87	14,92
92	97	102	123	123	152	162	172	192	212
137	142	147	159	179	196	206	216	236	256

142038520	142038523	142038525	142038530	142038535	142038540	142038545	142038550	142038560	142038570
3,39	3,86	4,55	5,84	7,33	10,33	11,61	13,60	18,00	22,98
185	199	208	232	258	349	373	398	447	496
229	243	252	276	302	387	411	436	485	534

142038820	142038823	142038825	142038830	142038835	142038840	142038845	142038850	142038860	142038870
3,98	4,86	5,12	6,74	8,18	11,36	12,78	14,94	19,50	24,90
185	199	208	232	258	430	441	452	474	496
229	243	252	276	302	468	479	490	512	534
150	150	150	200	200	250	250	250	250	250

142038720	142038723	142038725	142038730	142038735	142038740	142038745	142038750	142038760	142038770
3,98	4,86	5,12	6,74	8,18	11,36	12,78	14,94	19,50	24,90
185	199	208	232	258	430	441	452	474	496
229	243	252	276	302	468	479	490	512	534
150	150	150	200	200	250	250	250	250	250

ICS

SCHIEDEL ICS
Lieferprogramm (Stand 2010)

Lichter Ø **80** **100** **130** **150** **180**

V5



Bogen 90°

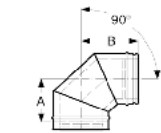

Art.-Nr.	142039008	142039010	142039013	142039015	142039018
Gewicht kg/Stk.	1,20	1,50	2,00	2,38	3,07
A	128	137	151	162	183
B	168	178	194	204	227

V6



Bogen 90° mit Revisionsverschluss für Festbrennstoff

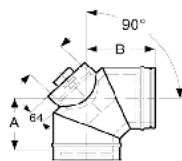

Art.-Nr.	142039308	142039310	142039313	142039315	142039318
Gewicht kg/Stk.	1,61	2,02	2,68	3,05	3,68
A	156	155	166	186	183
B	200	199	210	230	227
ØD	80	100	130	150	150

V7



Bogen 90° mit Revisionsverschluss für Öl, Gas

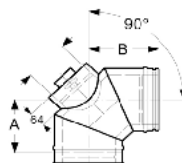

Art.-Nr.	142039208	142039210	142039213	142039215	142039218
Gewicht kg/Stk.	1,61	2,02	2,68	3,05	3,68
A	156	155	166	186	183
B	200	199	210	230	227
Ø D	80	100	130	150	150

V8



Rohrelement mit Messöffnung

für waagrechten und senkrechten Einbau

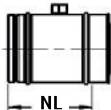

Art.-Nr.	266002508	266002510	266002513	266002515	266002518
Gewicht kg/Stk.	1,03	1,22	1,49	1,68	1,95
Nutzlänge (NL)	205	205	205	205	205
Außen Ø	130	150	180	200	230

V9



Rohrelement mit Kondensatablauf

für waagrechten Einbau

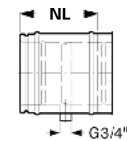

Art.-Nr.	266002808	266002810	266002813	266002815	266002818
Gewicht kg/Stk.	1,03	1,22	1,49	1,68	1,95
Nutzlänge (NL)	205	205	205	205	205
Außen Ø	130	150	180	200	230

V10



Rohrausgleichselement

für waagrechten Einbau
für Unterdruck

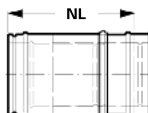

Art.-Nr.	142022808	142022810	142022813	142022815	142022818
Gewicht kg/Stk.	2,15	2,54	3,13	3,51	4,1
Nutzlänge (NL)	270-375	270-375	270-375	270-375	270-375
Außen Ø	130	150	180	200	230

V11



Unterstützung höhenverstellbar

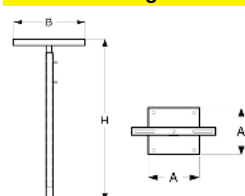

Art.-Nr.	95130001	95130001	95130001	95130001	95130001
Gewicht kg/Stk.	3,00	3,00	3,00	3,00	3,00
A	200	200	200	200	200
B	230	230	230	230	230
H	785-1300	785-1300	785-1300	785-1300	785-1300

Maße in mm

SCHIEDEL ICS
Lieferprogramm (Stand 2010)

*Lieferzeit 10 Arbeitstage

200	230	250	300	350*	400*	450*	500*	600*	700*
142039020	142039023	142039025	142039030	142039035	142039040	142039045	142039050	142039060	142039070
3,39	3,86	4,55	5,84	7,33	10,33	11,61	13,60	18,00	22,98
188	204	212	237	264	371	396	421	471	522
232	248	256	281	308	409	434	459	509	560

142039320	142039323	142039325	142039330	142039335	142039340	142039345	142039350	142039360	142039370
3,98	4,86	5,12	6,74	8,18	11,70	13,16	15,37	20,26	25,79
188	204	212	237	264	449	460	471	493	522
232	248	256	281	308	487	498	509	531	560
150	150	150	200	200	250	250	250	250	250

142039220	142039223	142039225	142039230	142039235	142039240	142039245	142039250	142039260	142039270
3,98	4,86	5,12	6,74	8,18	11,70	13,16	15,37	20,26	25,79
188	204	212	237	264	449	460	471	493	522
232	248	256	281	308	487	498	509	531	560
150	150	150	200	200	250	250	250	250	250

266002520	266002523	266002525	266002530	266002535	266002540	266002545	266002550	266002560	266002570
2,14	2,42	2,6	3,05	3,52	3,98	4,69	5,17	6,12	7,07
205	205	205	205	205	205	205	205	205	205
250	280	300	350	400	450	500	550	650	750

266002820	266002823	266002825	266002830	266002835	266002840	266002845	266002850	266002860	266002870
2,14	2,42	2,6	3,05	3,52	3,98	4,69	5,17	6,12	7,07
205	205	205	205	205	205	205	205	205	205
250	280	300	350	400	450	500	550	650	750

142022820	142022823	142022825	142022830	142022835	142022840	142022845	142022850	142022860	142022870
4,49	5,09	5,47	6,42	7,42	8,44	9,41	10,38	12,32	14,25
270-375	270-375	270-375	270-375	270-375	270-375	270-375	270-375	270-375	270-375
250	280	300	350	400	450	500	550	650	750

95130001	95130002	95130002	95130002	95130002	95130003	95130003	95130003	95130003	95130003
3,00	5,00	5,00	5,00	5,00	7,00	7,00	7,00	7,00	7,00
200	200	200	200	200	300	300	300	300	300
230	330	330	330	330	520	520	520	520	520
785-1300	840-1300	840-1300	840-1300	840-1300	840-1300	840-1300	840-1300	840-1300	840-1300