

SCHIEDEL PRIMA PLUS

Lieferprogramm

Lichter Ø mm **80** **100** **113** **120** **130** **140** **150**



1 Kondensatschale mit Ablauf

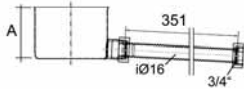

Art.-Nr.	265800008	265800010	265800011	265800012	265800013	265800014	265800015
Gewicht kg/Stk.	0,28	0,31	0,34	0,38	0,42	0,45	0,47
A (Nutzlänge)	70	70	70	70	70	70	70



2a Reinigungs T-Stück

für Putztüranschluss
für Unterdruck, Überdruck

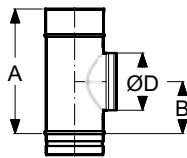

Art.-Nr.	238300908	238300910	238300911	238300912	238300913	238300914	238300915
Gewicht kg/Stk.	0,62	0,78	0,89	0,95	1,04	1,09	1,32
A (Nutzlänge)	283	283	283	283	283	283	325
B	115	115	115	115	115	115	137
ØD (Stutzen)	80	100	113	120	130	130	150



2b Revisionsverschluss FU, ÜD

für Öl, Gas
für Überdruck, Unterdruck
passend auf
Reinigungs T-Stück (2a)

Art.-Nr.	265820908	265820910	265820911	265820912	265820913	265820914	265820915
für Stutzen-Ø	80	100	113	120	130	130	150



2c Revisionsverschluss

für Festbrennstoffe
für Unterdruck
passend auf
Reinigungs T-Stück (2a)

Art.-Nr.	255160008	255160010	255160011	255160012	255160013	255160014	255160015
Gewicht kg/Stk.	0,17	0,23	0,26	0,33	0,33	0,33	0,41
für Stutzen-Ø	80	100	113	120	130	130	150



3 Putztüranschluss eckig

für Unterdruck, vor allem für
Festbrennstoffe

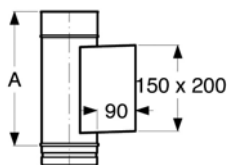

Art.-Nr.	-	-	235300511	235300512	235300513	235300514	235300515
Gewicht kg/Stk.			0,95	1,00	1,02	1,08	1,13
A (Nutzlänge)			325	325	325	325	325

inkl. inneren Verschlussdeckel



4a T-Stück 90° mit Stutzen (mit Normalrohren zu verlängern)

für Rauchrohranschluss
für Überdruck, Unterdruck

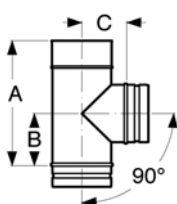

Art.-Nr.	231309008	231309010	231309011	231309012	231309013	231309014	231309015
Gewicht kg/Stk.	0,50	0,62	0,70	0,73	0,79	0,85	1,01
A (Nutzlänge)	283	283	283	283	283	283	325
B	118	118	118	118	118	118	139
C	74	84	91	94	99	104	109
Stutzen-Ø	80	100	113	120	130	140	150

SCHIEDEL PRIMA PLUS Lieferprogramm

*Lieferzeit 10 Arbeitstage

160 180 200 230* 250 300* 350* 400* 450* 500* 550* 600* 700*

265800016	265800018	265800020	265800023	265800025	265800030	265800035	265810040	265810045	265810050	265810055	265810060	265810070
0,50	0,57	0,66	0,73	0,80	0,72	0,89	1,90	2,05	2,43	2,85	3,30	4,29
70	70	70	70	70	70	70	70	70	70	70	70	70

238300916	238300918	238300920	238300923	238300925	238300930	238300935	238310940	238310945	238310950	238310955	238310960	238310970
1,38	1,49	1,60	1,77	1,88	2,97	3,34	5,02	5,65	6,28	6,91	7,54	8,79
325	325	325	325	450	450	450	450	450	450	450	450	450
137	137	137	137	200	200	200	200	200	200	200	200	200
150	150	200	200	250	300	300	300	300	300	300	300	300

265820915	265820915	265820920	265820920	265820925	265820930	265820930	265820930	265820930	265820930	265820930	265820930	265820930
150	150	200	200	250	300	300	300	300	300	300	300	300

255160015	255160015	255160020	255160020	255160025	255160030	255160030	255160030	255160030	255160030	255160030	255160030	255160030
0,41	0,41	0,55	0,55	0,79	0,84	0,84	0,84	0,84	0,84	0,84	0,84	0,84
150	150	200	200	250	300	300	300	300	300	300	300	300

235300516	235300518	235300520	235300523	235300525	235300530	235300530	-	-	-	-	-	-
1,20	1,29	1,39	1,55	1,64	1,92	1,92						
325	325	325	325	325	325	325						

231309016	231309018	231309020	231309023	231309025	231309030	231309035	231319040	231319045	231319050	231319055	231319060	231319070
1,13	1,53	1,70	1,92	2,09	2,48	2,84	6,05	8,99	10,76	12,68	14,76	19,37
350	450	450	450	450	450	450	530	580	630	680	730	830
150	200	200	200	200	200	200	240	265	290	315	340	390
114	124	134	144	157	182	207	240	265	290	315	340	390
160	180	200	230	250	300	350	400	450	500	550	600	700

SCHIEDEL PRIMA PLUS

Lieferprogramm

Lichter Ø mm **80** **100** **113** **120** **130** **140** **150**



4b T-Stück für Anschluss 90°

für Rauchrohranschluss
für Unterdruck

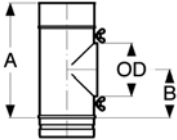

Art.-Nr.	-	-	238300511	238300512	238300513	238300514	238300515
Gewicht kg/Stk.			0,53	0,56	0,61	0,70	0,80
A (Nutzlänge)			283	283	283	283	325
B			115	115	115	137	110
ØD (Stutzen)			113	120	130	140	150



4c Anschluss glatt

für Unterdruck
für alle Brennstoffe, passend
auf Anschluss-T-Stück 90°

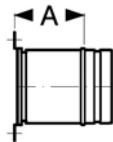

Art.-Nr.	-	-	242050011	242050012	242050013	242050014	242050015
Gewicht kg/Stk.			0,33	0,34	0,37	0,40	0,42
A (Nutzlänge)			150	150	150	150	150



4c Doppelwandfutter

für Unterdruck
für alle Brennstoffe
passend auf Pos. 3a

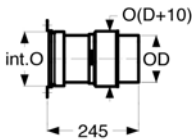

Lichter Ø mm	Kaminseite (Muffe)						
	80	100	113	120	130	140	150
Kesselseite Ø 80							
Art.-Nr.	-	242000810	-	-	-	-	-
Kesselseite Ø 90							
Art.-Nr.	-	242000910	242000911	-	-	-	-
Kesselseite Ø 100							
Art.-Nr.	-	242001010	242001011	242001012	242001013	-	-
Kesselseite Ø 113							
Art.-Nr.	-	242001110	242001111	242001112	242001113	-	-
Kesselseite Ø 120							
Art.-Nr.	-	242001210	242001211	242001212	242001213	242001214	-
Kesselseite Ø 130							
Art.-Nr.	-	242001310	242001311	242001312	242001313	242001314	242001315
Kesselseite Ø 140							
Art.-Nr.	-	-	-	-	-	242001414	-
Kesselseite Ø 150							
Art.-Nr.	-	-	-	242001512	242001513	242001514	242001515
Kesselseite Ø 160							
Art.-Nr.	-	-	-	-	-	242001614	242001615
Kesselseite Ø 180							
Art.-Nr.	-	-	-	-	242001813	242001814	242001815
Kesselseite Ø 200							
Art.-Nr.	-	-	-	-	-	-	-
Kesselseite Ø 250							
Art.-Nr.	-	-	-	-	-	-	-
Kesselseite Ø 300							
Art.-Nr.	-	-	-	-	-	-	-



Bogen 85° mit Stützfuß

für Abgasleitungen
für Überdruck, Unterdruck

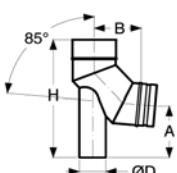

Art.-Nr.	137038708	137038710	137038711	137038712	137038713	137038714	137038715
Gewicht kg/Stk.	0,64	0,74	0,80	0,82	0,89	0,94	0,99
A	137	146	148	155	161	166	170
B	139	138	145	142	138	138	137
H	337	345	353	355	356	360	364
ØD	80	80	80	80	80	100	100

SCHIEDEL PRIMA PLUS Lieferprogramm

*Lieferzeit 10 Arbeitstage

160 180 200 230* 250 300* 350* 400* 450* 500* 550* 600* 700*

238300516	238300518	238300520	238300523	238300525	238300530							
0,91	1,32	1,46	1,88	2,03	2,49	-	-	-	-	-	-	-
350	450	450	450	450	450							
150	200	200	200	200	200							
160	180	200	230	250	300							

242050016	242050018	242050020	242050023	242050025	242050030							
0,45	0,54	0,59	0,67	0,72	0,85	-	-	-	-	-	-	-
150	150	150	150	150	150							

Kaminseite (Muffe)

160 180 200 230 250 300 350 400* 450* 500* 550* 600* 700*

-	-	-	-	-	-	-	-	-	-	-	-	-
-	-	-	-	-	-	-	-	-	-	-	-	-
-	-	-	-	-	-	-	-	-	-	-	-	-
-	-	-	-	-	-	-	-	-	-	-	-	-
-	-	-	-	-	-	-	-	-	-	-	-	-
-	-	-	-	-	-	-	-	-	-	-	-	-
242001316	-	-	-	-	-	-	-	-	-	-	-	-
-	-	-	-	-	-	-	-	-	-	-	-	-
242001516	242001518	-	-	-	-	-	-	-	-	-	-	-
242001616	242001618	-	-	-	-	-	-	-	-	-	-	-
242001816	242001818	242001820	-	-	-	-	-	-	-	-	-	-
-	242002018	242002020	242002023	-	-	-	-	-	-	-	-	-
-	-	242002520	242002523	242002525	-	-	-	-	-	-	-	-
-	-	-	-	242003025	242003030	-	-	-	-	-	-	-

137038716	137038718	137038720	137038723	137038725	137038730	137038735						
1,04	1,16	1,32	1,55	1,71	2,18	2,72	-	-	-	-	-	-
175	180	182	188	192	202	210						
140	142	155	168	176	200	226						
371	378	394	413	424	458	492						
100	100	150	150	150	200	200						

SCHIEDEL PRIMA PLUS

Lieferprogramm

Lichter Ø mm **80** **100** **113** **120** **130** **140** **150**



4f T-Stück 45°

für Überdruck, Unterdruck mit Kondensatrinne

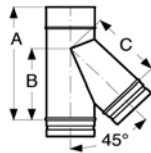

Art.-Nr.	231304508	231304510	231304511	231304512	231304513	231304514	231304515
Gewicht kg/Stk.	0,57	0,73	0,84	0,98	1,06	1,15	1,26
A (Nutzlänge)	283	283	283	283	325	325	325
B	160	170	180	180	205	210	215
C	133	153	168	178	188	198	213
Stutzen-Ø	80	100	113	120	130	140	150



5 Reduktionen/Erweiterungen

Baulänge: 150 mm

Kaminseite (Muffe)

Lichter Ø mm	80	100	113	120	130	140	150
Kesselseite Ø 80							
Art.-Nr.	-	267250810	267250811	267250812	267250813	-	-
Kesselseite Ø 100							
Art.-Nr.	-	-	267251011	267251012	267251013	267251014	267251015
Kesselseite Ø 113							
Art.-Nr.	-	267201110	-	267251112	267251113	267251114	267251115
Kesselseite Ø 120							
Art.-Nr.	-	267201210	267201211	-	267251213	267251214	267251215
Kesselseite Ø 130							
Art.-Nr.	-	267201310	267201311	267201312	-	267251314	267251315
Kesselseite Ø 150							
Art.-Nr.	-	-	-	267201512	267201513	267201514	-
Kesselseite Ø 160							
Art.-Nr.	-	-	-	-	267201613	267201614	267201615
Kesselseite Ø 180							
Art.-Nr.	-	-	-	-	267201813	267201814	267201815
Kesselseite Ø 200							
Art.-Nr.	-	-	-	-	-	-	267202015
Kesselseite Ø 230							
Art.-Nr.	-	-	-	-	-	-	-
Kesselseite Ø 250							
Art.-Nr.	-	-	-	-	-	-	-
Kesselseite Ø 300							
Art.-Nr.	-	-	-	-	-	-	-



6 Verschlussdeckel

für nicht angeschlossenen Rauchrohranschluss; passend auf Pos. 4b, 4c, 4d, 5a

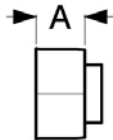

Art.-Nr.	265820808	265820810	265820811	265820812	265820813	265820814	265820815
A	60	73	73	73	73	73	73



7a Rohrelement 950

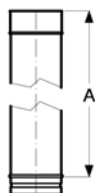

Art.-Nr.	137010008	137010010	137010011	137010012	137010013	137010014	137010015
Gewicht kg/Stk.	1,22	1,52	1,72	1,82	1,98	2,13	2,28
A (Nutzlänge)	950	950	950	950	950	950	950

SCHIEDEL PRIMA PLUS Lieferprogramm

*Lieferzeit 10 Arbeitstage

160	180	200	230*	250	300*	350*	400*	450*	500*	550*	600*	700*
231304516	231304518	231304520	231304523	231304525	231304530	231304535	231314540	231314545	231314550	231314555	231314560	231314570
1,42	1,92	2,17	2,54	3,23	4,37	5,08	10,99	12,58	15,96	18,14	21,59	28,71
350	450	450	450	540	617	617	710	780	850	950	1030	1200
235	295	305	320	375	440	465	535	595	655	720	800	950
228	258	281	313	358	418	448	535	595	655	720	790	925
160	180	200	230	250	300	350	400	450	500	550	600	700

Kaminseite (Muffe)												
160	180	200	230	250	300	350	400*	450*	500*	550*	600*	700*
-	-	-	-	-	-	-	-	-	-	-	-	-
-	-	-	-	-	-	-	-	-	-	-	-	-
-	-	-	-	-	-	-	-	-	-	-	-	-
-	-	-	-	-	-	-	-	-	-	-	-	-
267251316	267251318	-	-	-	-	-	-	-	-	-	-	-
267251516	267251518	267251520	-	-	-	-	-	-	-	-	-	-
-	267251618	267251620	-	-	-	-	-	-	-	-	-	-
267201816	-	267251820	267251823	267251825	-	-	-	-	-	-	-	-
267202016	267202018	-	267252023	267252025	-	-	-	-	-	-	-	-
-	267202318	267202320	-	267252325	-	-	-	-	-	-	-	-
-	267202518	267202520	267202523	-	267203025	-	-	-	-	-	-	-
-	-	-	-	267203025	-	267253035	267253040	-	-	-	-	-

265820816	265820818	265820820	265820823	265820825	265820830	265820835	-	-	-	-	-	-
73	73	73	73	73	73	73						

137010016	137010018	137010020	137010023	137010025	137010030	137010035	137110040	137110045	137110050	137110055	137110060	137110070
2,43	2,73	3,04	3,49	3,79	4,55	5,30	10,09	11,34	12,60	13,86	15,12	17,64
950	950	950	950	950	950	950	950	950	950	950	950	950

SCHIEDEL PRIMA PLUS

Lieferprogramm

Lichter Ø mm **80** **100** **113** **120** **130** **140** **150**



7b Rohrelement 450



Art.-Nr.	137005008	137005010	137005011	137005012	137005013	137005014	137005015
Gewicht kg/Stk.	0,61	0,76	0,86	0,91	0,99	1,07	1,14
A (Nutzlänge)	450	450	450	450	450	450	450



7c Rohrelement 200



Art.-Nr.	137002508	137002510	137002511	137002512	137002513	137002514	137002515
Gewicht kg/Stk.	0,31	0,38	0,43	0,46	0,49	0,53	0,57
A (Nutzlänge)	200	200	200	200	200	200	200



7d Rohrelement 1000 mit Doppelmuffe

für Unterdruck

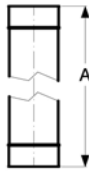

Art.-Nr.	137010108	137010110	137010111	137010112	137010112	137010114	137010115
Gewicht kg/Stk.	1,22	1,52	1,72	1,82	1,82	2,13	2,28
A	1000	1000	1000	1000	1000	1000	1000



7e Ablasselement

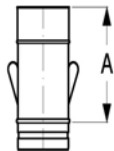

Art.-Nr.	137002408	137002410	137002411	137002412	137002413	137002414	137002415
Gewicht kg/Stk.	0,33	0,41	0,46	0,48	0,52	0,56	0,60
A (Nutzlänge)	200	200	200	200	200	200	200



8a Dichtring Silikon

für Überdruck bei Gas

Art.-Nr.	270301008	270301010	270301011	270301011	270301013	270301013	270301015
----------	-----------	-----------	-----------	-----------	-----------	-----------	-----------



8b Dichtring Viton

für Überdruck bei Gas

Art.-Nr.	270301208	270301210	270301211	270301211	270301213	270301213	270301215
----------	-----------	-----------	-----------	-----------	-----------	-----------	-----------



8c Klemmband

v.a für Verbindungsleitung
(auch für geschnittene
Rohre im Unterdruck)

Art.-Nr.	265822108	265822110	265822111	265822112	265822113	265822114	265822115
----------	-----------	-----------	-----------	-----------	-----------	-----------	-----------



8d Dichtset NT

v.a für Verbindungsleitung
(auch für geschnittene
Rohre im Unterdruck)

Art.-Nr.	267000508	267000510	267000511	267000512	267000513	267000514	267000515
----------	-----------	-----------	-----------	-----------	-----------	-----------	-----------

SCHIEDEL PRIMA PLUS Lieferprogramm

*Lieferzeit 10 Arbeitstage

160 180 200 230* 250 300* 350* 400* 450* 500* 550* 600* 700*

137005016	137005018	137005020	137005023	137005025	137005030	137005035	137105040	137105045	137105050	137105055	137105060	137105070
1,22	1,37	1,52	1,74	1,90	2,27	2,65	5,04	5,67	6,30	6,93	7,56	8,82
450	450	450	450	450	450	450	450	450	450	450	450	450

137002516	137002518	137002520	137002523	137002525	137002530	137002535	137102540	137102545	137102550	137102555	137102560	137102570
0,61	0,68	0,76	0,87	0,95	1,14	1,32	2,52	2,84	3,15	3,47	3,78	4,41
200	200	200	200	200	200	200	200	200	200	200	200	200

137010116	137010118	137010120	137010123	137010125	137010130	137010135	-	-	-	-	-	-
2,43	2,73	3,04	3,49	3,79	4,55	5,30						
1000	1000	1000	1000	1000	1000	1000						

137002416	137002418	137002420	137002423	137002425	137002430	137002435	137102440	137102445	137102450	137102455	137102460	137102470
0,63	0,71	0,79	0,90	0,97	1,16	1,35	2,57	2,90	3,25	3,57	3,88	4,52
200	200	200	200	200	200	200	200	200	200	200	200	200

270301015	270301018	270301020	270301023	270301025	270301030	270301035	270301040	270301045	270301050	270301055	270301060	270301070

270301215	270301218	270301220	270301223	270301225	270301230	270301235	-	-	-	-	-	-

265822116	265822118	265822120	265822123	265822125	265822130	265822135	265822140	265822145	265822150	265822155	265822160	265822170

267000516	267000518	267000520	267000523	267000525	267000530	267000535	-	-	-	-	-	-

SCHIEDEL PRIMA PLUS

Lieferprogramm

Lichter Ø mm **80** **100** **113** **120** **130** **140** **150**



9 Abstandhalter

Art.-Nr.	265822208	265822210	265822211	265822212	265822213	265822214	265822215



10 Wärmedämmung

vor allem für
Festbrennstoffe

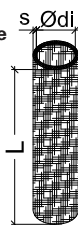

Art.-Nr.	-	163001210	163001211	163001212	163001213	163001214	163001215

Ødi		108	118	128	138	148	158
L		1000	1000	1000	1000	1000	1000
s		20	20	20	20	20	20



11a Schachtabdeckung

FU-Mündungslösung
in Verbindung mit
Mündungskonus bzw.
Regenkragen
(ab Ø 350)

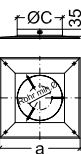

Befestigungs-
material
beigepackt

Art.-Nr.	354110001	354110001	354110001	354110001	354110002	354110002	354110002

ØC (innen)	180	180	180	180	225	225	225
□ a	350	350	350	350	400	400	400
Ø Rohr mind.	70	70	70	70	115	115	115



11b Mündungskonus

FU-Mündungslösung
immer in Verbindung mit
Schachtabdeckung

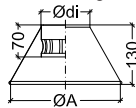

Art.-Nr.	350140008	350140010	350140011	350140012	350140013	350140014	350140015

Ødi	84	104	117	124	134	144	154
ØA	240	240	240	240	283	283	283



11c Regenkragen inkl. Dichtband

FU-Mündungslösung
ab Ø 350
immer in Verbindung mit
Schachtabdeckung

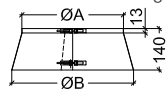

Art.-Nr.	-	-	-	-	-	-	-

ØA							
ØB							



11d Dehnfugenmanschette 2

FE-Mündungslösung

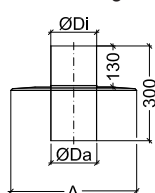

Art.-Nr.	353040208	353040210	353040209	353040212	353040213	353040214	353040215

ØDa (außen)	78	98	111	118	128	138	148
ØDi (innen)	80	100	113	120	130	140	150
□ A	350	350	350	350	400	400	400

SCHIEDEL PRIMA PLUS Lieferprogramm

*Lieferzeit 10 Arbeitstage

160 180 200 230* 250 300* 350* 400* 450* 500* 550* 600* 700*

265822216 265822218 265822220 265822223 265822225 265822230 265822235 265822240 265822245 265822250 265822255 265822260 265822270

163001216	163001218	163001220	163001223	163001225	163001230	-	-	-	-	-	-	-
168	188	208	238	258	308							
1000	1000	1000	1000	1000	1000							
20	20	20	20	20	20							

354110002	354110003	354110003	354110004	354110004	354110004	95530350	95530400	95530450	95530500	95530550	95530600	95530700
225	280	280	365	365	365	410	460	510	560	610	660	760
400	450	450	500	500	500	700	700	800	800	800	900	900
115	170	170	255	255	255	300	350	400	450	500	550	650

350140016	350140018	350140020	350140023	350140025	350140030	-	-	-	-	-	-	-
163	184	204	234	254	304							
283	337	337	422	422	422							

-	-	-	-	-	-	265830350	265830400	265830450	265830500	265830550	265830600	265830700
						350	400	450	500	550	600	700
						490	540	590	640	690	740	840

353040216	353040218	353040220	353040223	353040225	353040230	-	-	-	-	-	-	-
158	178	198	228	248								
160	180	200	230	250	298							
400	450	450	450	500	300							
					500							

SCHIEDEL PRIMA PLUS Lieferprogramm

Lichter Ø mm **80** **100** **113** **120** **130** **140** **150**



11e Regenhaube

passend in Mündungskonus und Dehnfugenmanschette 2
inkl. Sicherungsseil

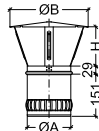

Art.-Nr.	025300808	025300810	025300911	025300812	025300813	025300814	025300815
Gewicht kg/Stk.	0,37	0,49	0,51	0,54	0,66	0,68	0,72
ØA (außen)	75	95	108	115	125	135	145
ØB	160	200	200	200	240	240	280
H	100	100	100	100	140	140	140



12 Zuluftgitter

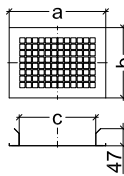

Art.-Nr.	025500018	025500018	025500018	025500018	025500018	025500018	025500018
a	265	265	265	265	265	265	265
b	193	193	193	193	193	193	193
c	206,5	206,5	206,5	206,5	206,5	206,5	206,5



13a Putztür-Edelstahl

gasdicht, passend auf die
Montagerahmen (13b, 13c)

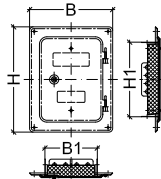

Art.-Nr.	255100504	255100504	255100504	255100504	255100504	255100505	255100505
Gewicht kg/Stk.	1,40	1,40	1,40	1,40	1,40	2,28	2,28
B	225	225	225	225	225	272	272
H	285	285	285	285	285	382	382
B1	140	140	140	140	140	190	190
H1	200	200	200	200	200	300	300



13b Montagerahmen 150

in Verbindung mit der
Putztür-Edelstahl (13a)

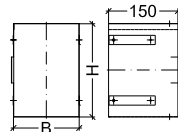

Art.-Nr.	255100604	255100604	255100604	255100604	255100604	255100605	255100605
B	141	141	141	141	141	193	193
H	201	201	201	201	201	303	303
Materialstärke: 1,0 mm							



13c Montagerahmen 250

in Verbindung mit der
Putztür-Edelstahl (13a)

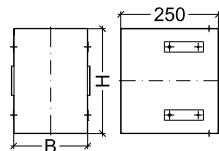

Art.-Nr.	255100614	255100614	255100614	255100614	255100614	255100615	255100615
B	141	141	141	141	141	193	193
H	201	201	201	201	201	303	303
Materialstärke: 1,0 mm							



13d Putztür mit Schieberahmen

gasdicht, aus Edelstahl,
passend zu Putztüranschluss
eckig (3)

Art.-Nr.	-	-	4008001	4008001	4008001	4008001	4008001
Außenmaß: 226 x 256 mm							
lichte Weite: 150 x 200 mm							
Einbautiefe: 240 mm							

SCHIEDEL PRIMA PLUS Lieferprogramm

*Lieferzeit 10 Arbeitstage

160 180 200 230* 250 300* 350* 400* 450* 500* 550* 600* 700*

025300816	025300818	025300820	025300823	025300825	025300830	-	-	-	-	-	-	-
0,84	1,05	1,27	1,50	1,61	1,96							
155	175	195	224	244	294							
280	330	380	410	430	480							
140	180	180	250	250	250							

025500018	025500018	025500025	025500025	025500025	025500025	025500025	025500025	025500025	025500025	025500025	025500025	025500025
265	265	353	353	353	353	353	353	353	353	353	353	353
193	193	193	193	193	193	193	193	193	193	193	193	193
206,5	206,5	294	294	294	294	294	294	294	294	294	294	294

255100505	255100505	255100505	255100505	255100505	255100505	255100505	255100505	255100505	255100505	255100505	255100505	255100505
2,28	2,28	2,28	2,28	2,28	2,28	2,28	2,28	2,28	2,28	2,28	2,28	2,28
272	272	272	272	272	272	272	272	272	272	272	272	272
382	382	382	382	382	382	382	382	382	382	382	382	382
190	190	190	190	190	190	190	190	190	190	190	190	190
300	300	300	300	300	300	300	300	300	300	300	300	300

255100605	255100605	255100605	255100605	255100605	255100605	255100605	255100605	255100605	255100605	255100605	255100605	255100605
193	193	193	193	193	193	193	193	193	193	193	193	193
303	303	303	303	303	303	303	303	303	303	303	303	303

255100615	255100615	255100615	255100615	255100615	255100615	255100615	255100615	255100615	255100615	255100615	255100615	255100615
193	193	193	193	193	193	193	193	193	193	193	193	193
303	303	303	303	303	303	303	303	303	303	303	303	303

4008001	4008001	4008001	4008001	4008001	4008001	4008001	4008001	-	-	-	-	-

PPL

SCHIEDEL PRIMA PLUS Lieferprogramm

Lichter Ø mm	80	100	113	120	130	140	150
--------------	-----------	------------	------------	------------	------------	------------	------------



13e Verlängerung für Schieberahmen

aus Edelstahl,
passend zu Putztür
mit Schieberahmen (13d)

Art.-Nr.	-	-	4008000	4008000	4008000	4008000	4008000
Breite: 155 mm							
Höhe: 215 mm							
Tiefe: 348 mm							



14a Anschlussblende

als Abdeckung der
Maueröffnung beim RA

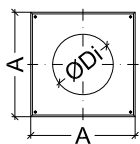

Art.-Nr.	ASBL08	ASBL10	ASBL11	ASBL13	ASBL13	ASBL15	ASBL15
A	250x250	250x250	250x250	250x250	250x250	340x340	340x340
ØDi	86	106	116	136	136	156	156
Zubehör: 4 Kreuzschlitzschrauben M4 x 30 mit weißem Kopf, 4 Universaldübel Ø 6 mm							
Material: Alu weiß RAL 9010, Wandstärke 1,5 mm							



14b Anschlussblende groß

als Abdeckung der
Maueröffnung beim RA

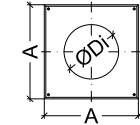

Art.-Nr.	-	ASBLG10	ASBLG11	ASBLG13	ASBLG13	-	-
A		340x340	340x340	340x340	340x340		
ØDi		106	116	136	136		
Zubehör: 4 Kreuzschlitzschrauben M4 x 30 mit weißem Kopf, 4 Universaldübel Ø 6 mm							
Material: Alu weiß RAL 9010, Wandstärke 1,5 mm							



14c Anschlussrosette EW

als Abdeckung der
Maueröffnung beim RA

**runde
alternative zu
Anschlussblende**

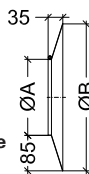

Art.-Nr.	265404708	265404710	265404707	265404712	265404713	265404714	265404715
ØA	80	100	113	120	130	140	150
ØB	250	270	283	290	300	310	320
- verstellbar							
- für nachträglichen Einbau geeignet							



15a Zugbegrenzer mit Explosionsklappe

passend in "Adapter für
Zugbegrenzer"

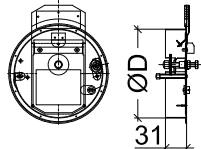

Art.-Nr.	-	255300001	255300001	255300001	255300001	255300001	255300001
Gewicht kg/Stk.		0,70	0,70	0,70	0,70	0,70	0,70
ØD (außen)		129,3	129,3	129,3	129,3	129,3	129,3



15b Adapter für Zugbegrenzer

passend zu "Zugbegrenzer
mit Explosionsklappe" (15a)

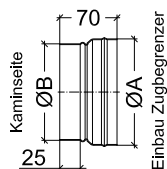

Art.-Nr.	-	265051313	265051313	265051313	265051313	265051313	265051313
ØA innen		130	130	130	130	130	130
ØB außen		127	127	127	127	127	127

Einbau in entsprechendem Doppelwandfutter (jew. auf Ø130 oder Ø180)

SCHIEDEL PRIMA PLUS Lieferprogramm

*Lieferzeit 10 Arbeitstage

160	180	200	230*	250	300*	350*	400*	450*	500*	550*	600*	700*
4008000	4008000	4008000	4008000	4008000	4008000	4008000	-	-	-	-	-	-
ASBL18	ASBL18	ASBL20	-	-	-	-	-	-	-	-	-	-
340x340	340x340	340x340										
186	186	206										
-	-	-	-	-	-	-	-	-	-	-	-	-
265404716	265404718	265404720	265404723	265404725	265404730	265404735	-	-	-	-	-	-
160	180	200	230	250	300	350						
330	350	370	400	420	470	520						
255300001	255300002	255300002	255300002	255300002	-	-	-	-	-	-	-	-
0,70	1,05	1,05	1,05	1,05								
129,3	179,3	179,3	179,3	179,3								
265051313	265051818	265051818	265051818	265051825	-	-	-	-	-	-	-	-
130	180	180	180	180								
127	177	177	177	242								

SCHIEDEL PRIMA PLUS

Lieferprogramm

Lichter Ø mm	80	100	113	120	130	140	150
--------------	----	-----	-----	-----	-----	-----	-----



15c Zugbegrenzer mit Explosionsklappe 300

für Ø350, Ø400 entsprechende Erweiterungen verwenden (3035, 3040) - siehe Pos. 5

Art.-Nr.	-	-	-	-	-	-	-
Gewicht kg/Stk.							
AußenØ - 290 mm							
Gesamtlänge - 132 mm							
Einstecktiefe - 45 mm							



15d Zugbegrenzer-Set mit Explosionsklappe

Einbau in Verbindungsleitung, passend auf T-Stück für Anschluss 90° (4b)

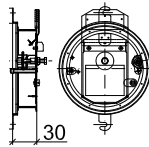

Art.-Nr.	-	026003010	026003007	026003012	026003013	026003014	026003015
Zugbegrenzer Ø		130	130	130	130	130	130



16 Mauerschelle für oberen PA

als statische Sicherung

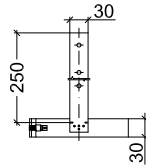

Art.-Nr.	265500201	265500202	265500203	265500204	265500204	265500205	265500206
Materialstärke: 1,0 mm							



17 Blitzschutzanschluss

Art.-Nr.	4008801	4008801	4008801	4008801	4008801	4008801	4008801



18a Verstellbogen 0-90°

für Verbindungsleitungen für trockene Betriebsweise, Unterdruck

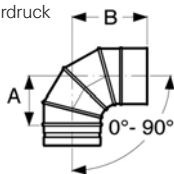

Art.-Nr.	-	-	137038911	137038912	137038913	137038914	137038915
Gewicht kg/Stk.			0,57	0,62	0,66	0,71	0,82
A			132	131	131	133	150
B			180	179	179	181	198



18b Verstellbogen 0-90° mit RV

für Verbindungsleitungen für trockene Betriebsweise, Unterdruck

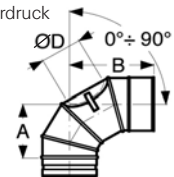

Art.-Nr.	-	-	137039211	137039212	137039213	137039214	137039215
Gewicht kg/Stk.			0,71	0,79	0,85	0,95	1,03
A			159	166	171	180	185
B			235	241	248	259	266
ØD			113	120	130	140	150

SCHIEDEL PRIMA PLUS Lieferprogramm

*Lieferzeit 10 Arbeitstage

160	180	200	230*	250	300*	350*	400*	450*	500*	550*	600*	700*	
-	-	-	-	-	025301030	025301030	025301030	-	-	-	-	-	
					4,62	4,62	4,62						
					Erweiterung	Erweiterung							
					3035	3040							
					verwenden	verwenden							
026003016	026003018	026003020	026003023	026003025	-	-	-	-	-	-	-	-	
130	130	180	180	180									
265500206	265500207	265500208	265500209	265500210	265500212	-	-	-	-	-	-	-	
4008801	4008801	4008801	4008801	4008801	4008801	4008801	4008801	4008802	4008802	4008802	4008802	4008802	-
137038916	137038918	137038920	137038923	137038925	137038930	-	-	-	-	-	-	-	-
0,88	1,01	1,18	1,47	1,63	2,18								
150	156	168	187	194	224								
198	204	216	235	242	272								
137039216	137039218	137039220	137039223	137039225	137039230	-	-	-	-	-	-	-	-
1,11	1,26	1,41	1,65	1,80	2,20								
190	194	198	207	211	220								
269	269	270	271	272	272								
150	150	150	150	150	150								

SCHIEDEL PRIMA PLUS

Lieferprogramm

Lichter Ø mm **80** **100** **113** **120** **130** **140** **150**



19a Bogen starr 90°

für Überdruck, Unterdruck

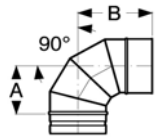

Art.-Nr.	137039008	137039010	137039011	137039012	137039013	137039014	137039015
Gewicht kg/Stk.	0,37	0,47	0,57	0,61	0,66	0,71	0,82
A	112	119	132	131	131	133	150
B	160	167	180	179	179	181	198



19b Bogen starr 90° + RV, Überdruck

für Überdruck, Unterdruck

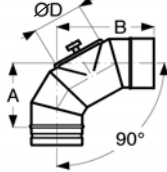

Art.-Nr.	137039108	137039110	137039111	137039112	137039113	137039114	137039115
Gewicht kg/Stk.	0,59	0,78	0,93	1,02	1,11	1,20	1,50
A	107	119	128	132	140	139	151
B	158	170	179	183	191	190	202
ØD	80	100	113	120	130	130	150



19c Bogen starr 85°

für Überdruck, Unterdruck

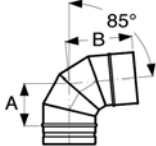

Art.-Nr.	137038508	137038510	137038511	137038512	137038513	137038514	137038515
Gewicht kg/Stk.	0,36	0,47	0,53	0,59	0,64	0,71	0,78
A	107	116	116	125	125	130	134
B	155	164	164	173	173	178	182



19d Bogen starr 85° + RV

für Überdruck, Unterdruck

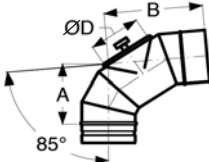

Art.-Nr.	137038608	137038610	137038611	137038612	137038613	137038614	137038615
Gewicht kg/Stk.	0,59	0,78	0,93	1,02	1,11	1,20	1,50
A	104	116	125	129	137	136	147
B	155	167	176	179	187	186	197
ØD	80	100	113	120	130	130	150



19e Bogen starr 45°

für Überdruck, Unterdruck

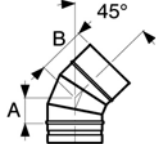

Art.-Nr.	137034508	137034510	137034511	137034512	137034513	137034514	137034515
Gewicht kg/Stk.	0,28	0,37	0,41	0,46	0,49	0,53	0,57
A	63	69	69	69	74	74	74
B	111	117	117	117	122	122	122



19f Bogen starr 30°

für Überdruck, Unterdruck

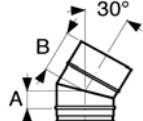

Art.-Nr.	137033008	137033010	137033011	137033012	137033013	137033014	137033015
Gewicht kg/Stk.	0,23	0,29	0,34	0,37	0,40	0,43	0,46
A	44	44	49	49	49	49	49
B	92	92	97	97	97	97	97

SCHIEDEL PRIMA PLUS Lieferprogramm

*Lieferzeit 10 Arbeitstage

160 180 200 230* 250 300* 350* 400* 450* 500* 550* 600* 700*

137039016	137039018	137039020	137039023	137039025	137039030	137039035	137139040	137139045	137139050	137139055	137139060	137139070
0,88	1,01	1,18	1,47	1,63	2,18	2,65	5,55	6,69	7,94	9,29	10,74	13,94
150	156	168	187	194	224	237	271	295	320	350	374	433
198	204	216	235	242	272	285	318	342	367	397	421	480

137039116	137039118	137039120	137039123	137039125	137039130	137039135	137139140	137139145	137139150	137139155	137139160	137139170
1,58	1,72	1,87	2,14	2,29	2,68	3,16	5,60	6,81	8,06	9,41	10,86	14,06
152	151	163	178	187	214	238	271	295	320	350	374	433
203	202	214	229	238	265	289	318	342	367	397	421	480
150	150	150	150	150	200	200	250	250	250	250	250	250

137038516	137038518	137038520	137038523	137038525	137038530	137038535	137138540	137138545	137138550	137138555	137138560	137138570
0,86	1,01	1,17	1,40	1,57	2,09	2,60	5,45	6,69	7,94	9,29	10,74	13,94
144	153	162	171	180	207	225	253	277	300	324	348	395
192	201	210	219	228	255	273	300	324	347	371	395	442

137038616	137038618	137038620	137038623	137038625	137038630	137038635	137138640	137138645	137138650	137138655	137138660	137138670
1,58	1,72	1,87	2,12	2,29	2,68	3,11	5,50	6,81	8,06	9,41	10,86	14,06
149	148	159	174	183	209	233	253	277	300	324	348	395
199	198	210	224	233	260	283	300	324	347	371	395	442
150	150	150	150	150	200	200	250	250	250	250	250	250

137034516	137034518	137034520	137034523	137034525	137034530	137034535	137134540	137134545	137134550	137134555	137134560	137134570
0,61	0,74	0,85	1,01	1,10	1,41	1,76	3,53	4,08	4,79	5,54	6,35	8,12
74	84	89	95	95	105	116	120	130	140	150	160	185
122	132	137	143	143	153	164	167	177	187	197	207	232

137033016	137033018	137033020	137033023	137033025	137033030	137033035	137133040	137133045	137133050	137133055	137133060	137133070
0,51	0,57	0,67	0,80	0,87	1,14	1,32	2,72	3,40	3,91	4,44	4,99	6,35
54	54	59	64	64	74	74	90	100	105	110	120	130
102	102	107	112	112	122	122	137	147	152	157	167	177

SCHIEDEL PRIMA PLUS

Lieferprogramm

Lichter Ø mm **80** **100** **113** **120** **130** **140** **150**



19g Bogen starr 15°

für Überdruck, Unterdruck

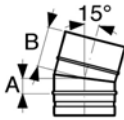

Art.-Nr.	137031508	137031510	137031511	137031512	137031513	137031514	137031515
Gewicht kg/Stk.	0,22	0,27	0,31	0,33	0,36	0,38	0,41
A	39	39	39	39	39	39	39
B	87	87	87	87	87	87	87



20a Rohrausgleichselement FU

inkl. Dichtset NT
für Überdruck,
für Öl, Gas

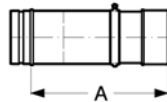

Art.-Nr.	137021008	137021010	137021011	137021012	137021013	137021014	137021015
Gewicht kg/Stk.	0,66	0,83	0,93	0,98	1,06	1,14	1,23
A - min.	270	270	270	270	270	270	270
A - max.	415	415	415	415	415	415	415



20b Rohrausgleichselement FE

für Unterdruck,
für trockene Betriebsweise,
inkl. Klemmband
v.a. für Festbrennstoffe

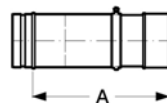

Art.-Nr.	137021108	137021110	137021111	137021112	137021113	137021114	137021115
Gewicht kg/Stk.	0,66	0,83	0,93	0,98	1,06	1,14	1,23
A - min.	270	270	270	270	270	270	270
A - max.	415	415	415	415	415	415	415



21 Rohr mit Kondensatablauf

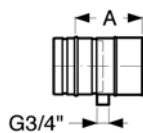

Art.-Nr.	137022508	137022510	137022511	137022512	137022513	137022514	137022515
Gewicht kg/Stk.	0,30	0,36	0,41	0,43	0,46	0,50	0,53
A	150	150	150	150	150	150	150



22a Rohrschelle Edelstahl

für Abstützung/Aufhängung
- Verbindungsleitung
- Abgasleitungsbogen

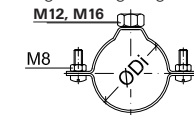

Art.-Nr.	267000308	267000310	267000311	267000312	267000313	267000314	267000315
Ødi	77-84	97-104	109-114	116-123	125-131	139-145	145-151
Innengewinde	M12	M12	M12	M12	M12	M16	M16



22b Gewindestange

1 m, Stahl verzinkt
passend zu Rohrschelle und
Befestigungsgrundplatte

Art.-Nr.	267000401	267000401	267000401	267000401	267000401	GEWR	GEWR
Länge 1 m							
Gewinde	M12	M12	M12	M12	M12	M16	M16



22c Befestigungsgrundplatte

Stahl verzinkt
passend zu Gewindestange
und Rohrschelle

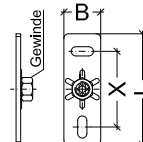

Art.-Nr.	267000402	267000402	267000402	267000402	267000402	GRPL	GRPL
L	80	80	80	80	80	120	120
B	30	30	30	30	30	40	40
X	55	55	55	55	55	80	80
Gewinde	M12	M12	M12	M12	M12	M16	M16

SCHIEDEL PRIMA PLUS Lieferprogramm

*Lieferzeit 10 Arbeitstage

160 180 200 230* 250 300* 350* 400* 450* 500* 550* 600* 700*

137031516	137031518	137031520	137031523	137031525	137031530	137031535	137131540	137131545	137131550	137131555	137131560	137131570
0,46	0,52	0,58	0,70	0,76	0,91	1,11	2,32	2,61	3,02	3,47	3,78	4,78
44	44	44	49	49	49	54	65	65	70	75	75	85
92	92	92	97	97	97	102	112	112	117	122	122	132

137021016	137021018	137021020	137021023	137021025	137021030	137021035	-	-	-	-	-	-
1,31	1,47	1,63	1,87	2,03	2,44	2,84						
270	270	270	270	270	270	270						
415	415	415	415	415	415	415						

137021116	137021118	137021120	137021123	137021125	137021130	137021135	137121140	137121145	137121150	137121155	137121160	137121170
1,31	1,47	1,63	1,87	2,03	2,44	2,84	5,42	5,71	6,36	6,99	7,62	8,89
270	270	270	270	270	270	270	270	270	270	270	270	270
415	415	415	415	415	415	415	415	415	415	415	415	415

137022516	137022518	137022520	137022523	137022525	137022530	137022535	137122540	137122545	137122550	137122555	137122560	137122570
0,57	0,63	0,70	0,80	0,87	1,04	1,04	2,30	2,21	2,46	2,70	2,95	3,44
150	150	150	150	150	150	150	150	150	150	150	150	150

267000316	267000318	267000320	-	267000325	267000330	-	-	-	-	-	-	-
156-162	175-180	190-200		244-253	295-305							
M16	M16	M16		M16	M16							

GEWR	GEWR	GEWR	-	GEWR	GEWR	GEWR	-	-	-	-	-	-
M16	M16	M16		M16	M16	M16						

GRPL	GRPL	GRPL	-	GRPL	GRPL	GRPL	-	-	-	-	-	-
120	120	120		120	120							
40	40	40		40	40	20						
80	80	80		80	80	40						
M16	M16	M16		M16	M16	80						
						M16						

SCHIEDEL PRIMA PLUS

Lieferprogramm

Lichter Ø mm **80** **100** **113** **120** **130** **140** **150**

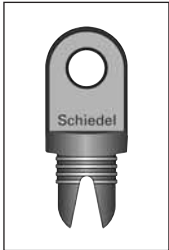

23 Messstopfen

für Rauchgasmessungen,
Einbau in Verbindungsleitung

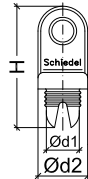

Art.-Nr.	265000002	265000002	265000002	265000002	265000002	265000002	265000002
Ød1	12	12	12	12	12	12	12
Ød2	18	18	18	18	18	18	18
H	44	44	44	44	44	44	44

Bohrung Ø 12 mm bauseits herstellen



24a Kesselanschluss Öl, Gas

aus Edelstahl mit Dichtung
und thermischer Trennung

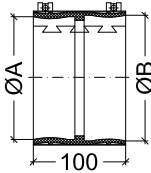

Art.-Nr.	-	265000110	265000111	265000112	265000113	265000114	265000115
Gewicht kg/Stk.		0,60	0,60	0,60	0,70	0,80	0,80
ØA max.		103	113	123	133	143	153
ØB max.		105	115	125	135	145	155

Temperaturgrenze: 200° C

Reduziermöglichkeit um 1 Durchmesser → halbes Silikonband einlegen (siehe Zubehör)



24b Kesselanschluss Festbrennstoff

aus Edelstahl mit Vlies

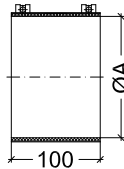

Art.-Nr.	265000508	265000510	265000511	265000512	265000513	265000514	265000515
Gewicht kg/Stk.	0,50	0,60	0,60	0,60	0,70	0,75	0,80
ØA max.	83	103	113	123	133	143	153

Reduziermöglichkeit um 1 Durchmesser → doppeltes einlegen einer Bandhälfte



25a Prima Plus Flex

innen glatt
Wandstärke 2 x 0,12 mm

**gewünschte Länge
wird geliefert**

Art.-Nr.	137801008	137801010	137801011	137801012	137801013	137801014	137801015
Gewicht kg/lfm	0,60	0,80	0,90	1,05	1,15	1,23	1,33
lfm/Rolle	60	60	50	50	50	30	30
lfm/Pal.	120	120	100	100	100	60	60
max. AußenØ	106	106	126	126	136	156	156
Werkstoff-Nr.: 1.4404							



25b Verbinder starr/Flex

von starr auf Flex
(in Rauchgasrichtung)

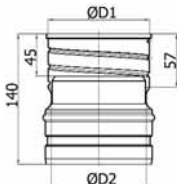

Art.-Nr.	265940508	265940510	265940511	265940512	265940513	265940514	265940515
ØD1	89,3	108,3	119	129	139,1	149,1	159
ØD2	81,1	101,2	112	121,2	131,1	141,3	151,2



25c Verbinder Flex/starr

von Flex auf starr
(in Rauchgasrichtung)

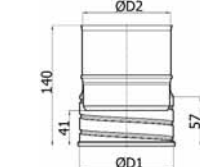

Art.-Nr.	265940608	265940610	265940611	265940612	265940613	265940614	265940615
ØD1	89,3	108,3	119	129	139,1	149,1	159
ØD2	81,1	101,2	112	121,2	131,1	141,3	151,2

SCHIEDEL PRIMA PLUS Lieferprogramm

*Lieferzeit 10 Arbeitstage

160 180 200 230* 250 300* 350* 400* 450* 500* 550* 600* 700*

265000002	265000002	265000002	265000002	265000002	265000002	265000002	265000002	265000002	265000002	265000002	265000002	265000002
12	12	12	12	12	12	12	12	12	12	12	12	12
18	18	18	18	18	18	18	18	18	18	18	18	18
44	44	44	44	44	44	44	44	44	44	44	44	44

265000116	265000118	265000120	-	265000125	265000130	-	-	-	-	-	-	-
0,90	0,90	1,00		1,20	1,30							
163	183	203		253	305							
165	185	205		255	307							

265000516	265000518	265000520	-	265000525	265000530	-	-	-	-	-	-	-
0,90	0,90	1,00		1,20	1,30							
163	183	203		253	305							

137801016	137801018	137801020	137801023	137801025	137801030	-	-	-	-	-	-	-
1,40	1,60	1,75	2,00	2,20	2,65							
25	25	20	20	20	20							
50	50	40	40	40	40							
186	186	206	206	206	206							

265940516	265940518	265940520	265940523	265940525	265940530	-	-	-	-	-	-	-
169,3	189,4	209,4	234,4	259	309,9							
161,3	181,1	201,1	226,3	251,1	301,1							

265940616	265940618	265940620	265940623	265940625	265940630	-	-	-	-	-	-	-
169,3	189,4	209,4	234,4	259	309,9							
161,3	181,1	201,1	226,3	251,1	301,1							

SCHIEDEL PRIMA PLUS Lieferprogramm

Lichter Ø mm **80** **100** **113** **120** **130** **140** **150**



25d Verbinder Flex/Flex

verbindet 2 prima Plus Flex
Rohre

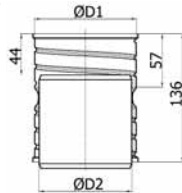

Art.-Nr.	265940708	265940710	265940711	265940712	265940713	265940714	265940715
ØD1	89,3	108,3	119	129	139,1	149,1	159
ØD2	79,2	99	108,8	119	128,9	139,1	148,9



26 Mauerschelle für Prima Plus Flex

zur Zentrierung und
statischen Sicherung
der Flex-Rohrsäule

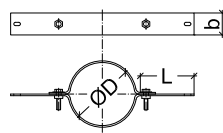

Art.-Nr.	265000308	265000310	265000311	265000312	265000313	265000314	265000315
ØD (innen)	80	100	113	120	130	140	150
L	100	100	100	100	100	100	100
b	40	40	40	40	40	40	40

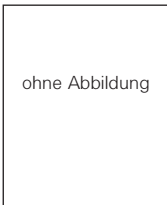

27 Adapter DrehFix - Prima Plus

verbindet DrehFix (unten)
mit Prima Plus (oben)

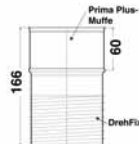

Art.-Nr.	-	265801610	-	265801612	265801613	-	265801615
----------	---	-----------	---	-----------	-----------	---	-----------



28 Universalmörtel weiß

für Mauer- und
Verputzarbeiten
im Innenbereich

Art.-Nr.	251000005
1 Sack = 25 kg	
42 Säcke/Pal.	



Rotempo

für Unter- und Überdruck
Öl, Gas bis 200 °C

Art.-Nr.	025500400
Stk./Karton	20
Inhalt in ml	310

SCHIEDEL PRIMA PLUS Lieferprogramm

*Lieferzeit 10 Arbeitstage

160	180	200	230*	250	300*	350*	400*	450*	500*	550*	600*	700*
-----	-----	-----	------	-----	------	------	------	------	------	------	------	------

265940716	265940718	265940720	265940723	265940725	265940730	-	-	-	-	-	-	-
169,3	189,4	209,4	234,4	259	309,9							
159,1	178,9	198,9	224,1	248,9	298,9							

265000316	265000318	265000320	265000323	265000325	265000330	-	-	-	-	-	-	-
160	180	200	230	250	300							
100	100	100	100	100	100							
40	40	40	40	40	40							

-	265801618	265801620	-	-	-	-	-	-	-	-	-	-

SCHIEDEL PRIMA PLUS

Materialaufstellung

Pos.	Bezeichnung	Art.-Nr.	Menge	E-Preis	G-Preis
1	Kondensatschale mit Ablauf	2658.....			
2a	Reinigungs T-Stück	2383.....			
2b	Revisionsverschluss FU, ÜD	2658209..			
2c	Revisionsverschluss	2551600..			
3	Putztüranschluss eckig	2353005..			
4a	T-Stück 90° mit Stutzen	2313090..			
4b	T-Stück für Anschluss 90°	2383005..			
4c	Anschluss glatt	2420500..			
4d	Doppelwandfutter	24200....			
4e	Bogen 85° mit Stützfuß	1370387..			
4f	T-Stück 45°	2313.....			
5	Reduktionen/Erweiterungen	2672.....			
6	Verschlussdeckel	2658208..			
7a	Rohrelement 950	137.....			
7b	Rohrelement 450	137.....			
7c	Rohrelement 200	137.....			
7d	Rohrelement 1000 m. Doppelm.	1370101..			
7e	Ablasselement	137.....			
8a	Dichtring Silikon	2703010..			
8b	Dichtring Viton	2703012..			
8c	Klemmband	2658221..			
8d	Dichtset NT	2670005..			
9	Abstandhalter	2658222..			
10	Wärmedämmung	1630012..			
11a	Schachtabdeckung	35411000/95530..			
11b	Mündungskonus	3501400..			
11d	Dehnfugenmanschette 2	3530402..			
11e	Regenhaube	025300...			
12	Zuluftgitter	0255000..			
13a	Putztür-Edelstahl	2551005..			
13b	Montagerahmen 150	2551006..			
13c	Montagerahmen 250	2551006..			
14a	Anschlussblende	ASBL..			
14c	Anschlussrosette EW	2654047..			
15a	Zugbegrenzer m. Expl.-Klappe	25530000.			
15b	Adapter für Zugbegrenzer	26505....			
15d	Zugbegrenzer-Set m. Expl.-Klappe		0260030..		
16	Mauerschelle für oberen PA	2655002..			
18a	Verstellbogen 0 - 90°	1370389..			
18b	Verstellbogen 0 - 90° mit RV	1370392..			
19a	Bogen starr 90°	137.....			
19b	Bogen starr 90° + RV, ÜD	137.....			
19c	Bogen starr 85°	137.....			
19d	Bogen starr 85° + RV	137.....			
19e	Bogen starr 45°	137.....			
19f	Bogen starr 30°	137.....			
19g	Bogen starr 15°	137.....			
20a	Rohrausgleichselement FU	137.....			
20b	Rohrausgleichselement FE	137.....			
21	Rohr mit Kondensatablauf	137.....			
22a	Rohrschelle Edelstahl	2670003..			
23	Messstopfen	265000002			
24a	Kesselanschluss Öl, Gas	2650001..			
24b	Kesselanschluss Festbrennstoff	2650005..			
25a	Prima Plus Flex	1378010..			
25b	Verbinder starr/Flex	2659405..			
25c	Verbinder Flex /starr	2659406..			
25d	Verbinder Flex/Flex	2659407..			
26	Mauerschelle f. Prima Flex Plus	2650003..			
28	Universalmörtel weiß	251000005			
29	Rotempo	025500400			
Summe					

SCHIEDEL PRIMA PLUS Systemdarstellung

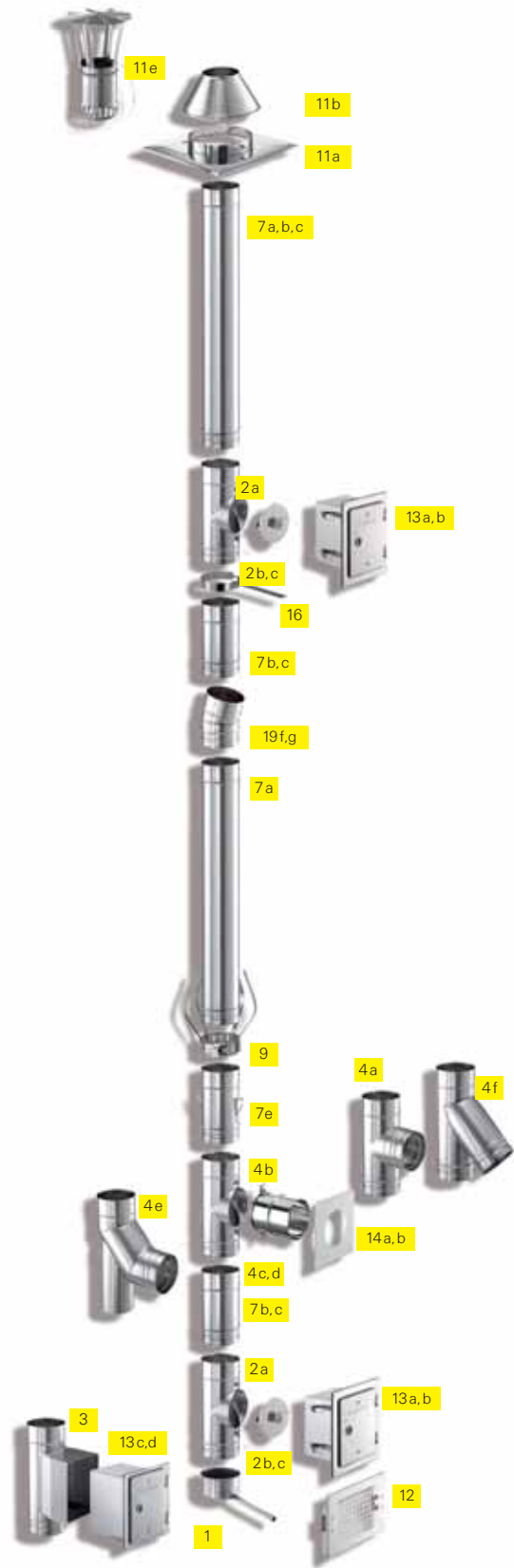

PPL